

HITACH

Instruction Manual

8

8mm Video Camcorder

VM-E220A



Hitachi Home Electronics (America), Inc.
3890 Steve Reynolds Blvd., Norcross, GA 30093
Tel. 770-279-5600

HITACHI (HSC) CANADA INC
3300 Trans Canada Highway, Pointe Claire,
Quebec, H9R 1B1, CANADA
Tel. 514-697-9150

HITACHI SALES CORPORATION OF HAWAII, INC
3219 Koapaka Street, Honolulu, Hawaii 96819
Tel. 808-836-3621

Thank you for buying a Hitachi product. Please take time to become familiar with the manual and how it is set up. Keep it handy for feature reference.

QR14541 © Hitachi, Ltd. 1996

Printed in Japan KR-H(N)

TABLE OF CONTENTS

Important Safeguards	4
IMPORTANT SAFETY INSTRUCTIONS FOR AC ADAPTER/CHARGER	6
Read This First.....	7
Before You Begin	7
Features	8
Components and Accessories.....	8
Optional RF Adapter	8
Lens Cap.....	8
Getting Started.....	9
Charging the Battery	9
Adjusting the Electronic Viewfinder	11
Eyepiece Adjustment	11
Adjustment the Hand Strap.....	11
Loading Batteries.....	11
Using Alternative Power Sources	16
Inserting and Removing Cassettes.....	17
Using the Linear Time Counter	18
Remaining Tape	18
Setting the Date and Time	18
Getting Started, Identifying Controls	19
Basic Techniques	21
Making a Basic Recording	21
Playing Back Your Recording.....	22
Advanced Techniques	24
Date Recording.....	25
Using the Power Zoom	26
Using the Digital Zoom	26
Using the INST. ZOOM (Instant Zoom) Button.....	27
Using Auto Focus	27
Using Manual Focus	28
Using Instant Review	28
Using Quick Edit	29
Using Macro	29
Date Search.....	29
Dubbing from the camcorder to a VCR.....	30
Recording Television Programs.....	30
Using the Optional Wireless Remote Control	31
Using Memory	33
Using the Display Button	33
Creating and Recording A Title	33
Using Audio/Video Dubbing.....	35
Using Synchro Edit.....	36
Simple Programmable Edit (Edit remote control is optional accessory).....	36
Attaching the Optional Wide or Tele Converter Lens	39
Attaching the Optional DC Camera Light	39
Viewfinder Bright, Color and Tint Control	41
General Maintenance.....	41
Cleaning the camcorder Heads.....	41
Cleaning the Lens and Picture Tube of the Electronic Viewfinder	42

Periodic Maintenance 42
 Troubleshooting 42
 Specifications 46
 Accessories Add Excitement 47
 Available Accessories 47
 More Available Accessories 47
 To Order in the United States 47

For Your Safety

The CAM/OFF/VIDEO switch turns the camcorder on and off, leaving the date/time feature unaffected. If the unit is to be left unattended for a long period of time, turn the camcorder off and attach the lens cap.

WARNING: TO PREVENT FIRE OR SHOCK HAZARD, DO NOT EXPOSE THIS UNIT TO RAIN OR MOISTURE.

The camcorder and AC adapter/charger have the following caution marks.



Identifications of caution marks



This symbol warns the user that uninsulated voltage within the unit may have sufficient magnitude to cause electrical shock. Therefore, it is dangerous to make any kind of contact with any inside part of this unit.



This symbol alerts the user that important literature concerning the operation and maintenance of this unit has been included. Therefore, it should be read carefully to avoid any problems.

**CAUTION: TO REDUCE THE RISK OF ELECTRIC SHOCK, DO NOT OPEN.
NO USER-SERVICEABLE PARTS INSIDE.
REFER SERVICING TO QUALIFIED SERVICE PERSONNEL.**

WARNING: TO PREVENT FIRE OR ELECTRIC SHOCK, MATCH WIDE BLADE OF PLUG TO WIDE SLOT, AND FULLY INSERT PLUG.

WARNING: Many television programs and films are copyrighted. In certain circumstances, copyright law may apply to private in-home videotaping of copyrighted materials.

This Class B digital apparatus meets all requirements of the Canadian Interference-Causing Equipment Regulations.

The liquid crystal display (LCD) panel is made by highly precise technology. More than 99.99% of its picture elements (pixels) are effective, but some (less than 0.01%) may appear as colored bright dots. This does not indicate a fault as the LCD panel stretches the limits of current technology.

Warning: This device complies with Part 15 of the FCC Rules. Operation is subject to the following two conditions: (1) This device may not cause harmful interference, and (2) this device must accept any interference received, including interference that may cause undesired operation.

Note: This equipment has been tested and found to comply with the limits for a Class B digital device, pursuant of Part 15 of the FCC Rules. These limits are designed to provide reasonable protection against harmful interference in a residential installation. This equipment generates, uses, and can radiate radio frequency energy and, if not installed and used in accordance with the instructions, may cause harmful interference to radio communications. However, there is no guarantee that interference will not occur in a particular installation. If this equipment does cause harmful interference to radio or television reception, which can be determined by turning the equipment off and on, the user is encouraged to try to correct by one or more of the following measures:

- Reorient or relocate the receiving antenna.
- Increase the separation between the equipment and receiver.
- Connect the equipment into an outlet on a circuit different from that to which the receiver is connected.
- Consult the dealer or an experienced radio/TV technician for help.

Caution to the user: Changes or modifications not expressly approved by the manufacture could void the user's authority to operate the equipment.

"Note to CATV system installer: This reminder is provided to call the CATV system installer's attention to Article 820-40 of the NEC that provides guidelines for proper grounding and, in particular, specifies that the cable ground shall be connected to the grounding system of the building, as close to the point of cable entry as practical".

Notes:

- This unit uses 8mm video format cassettes.
- It records and plays back in the SP mode (14.3 mm/sec).
- It cannot record and play back in the LP mode (7.2 mm/sec).

MOISTURE

Avoid operating your camcorder immediately after moving it from a cold place to a warm, humid place. Give the camcorder 2 to 3 hours to stabilize in the ambient conditions of the surroundings before inserting a cassette. When moved from a cold place to a warm, humid place, moisture may condense on the head drum inside the machine. This moisture could cause the tape to stick to the headwheel and damage the headwheel or tape.

When a small amount of moisture is sensed, "TAPE" flashes in the viewfinder. Remove the cassette and set the CAM/OFF/VIDEO switch to OFF, then wait for about one hour.

Important Safeguards

In addition to the careful attention devoted to quality standards in the manufacture of your video product, safety is a major factor in the design of every instrument. But, safety is your responsibility too. This page lists important information that will help to assure your enjoyment and proper use of a Video camcorder and accessory equipment. Please read it carefully before operating your video product and keep it in a handy place for future reference.

INSTALLATION

1 Read and Follow Instructions -- All the safety and operating instructions should be read before the video product is operated. Follow-all operating and use instructions.



2 Retain Instructions -- The safety and operating instructions should be retained for future reference.

3 Heed Warnings -- Comply with all warnings on the video product and in the operating instructions.

4 Polarized Plug -- This video product is equipped with a polarized alternating-current line plug (a plug having one blade wider than the other). This plug will fit into the power outlet only one way. This is a safety feature. If you are unable to insert the plug fully into the outlet, try reversing the plug. If the plug should still fail to fit, contact your electrician to replace your obsolete outlet. To prevent electric shock do not use this polarized plug with an extension cord, receptacle or other outlet unless the blades can be fully inserted without blade exposure. If you need an extension, use a polarized cord.



5 Power Sources -- This video product should be operated only from the type of power source indicated on the marking label. If you are not sure of the type of power supply to your home, consult your video dealer or local power company. For video products intended to operate from battery power, or other sources, refer to the operating instructions.

6 Overloading -- Do not overload wall outlets and extension cords as this can result in a risk of fire or electric shock. Overloaded AC outlets and extension cords are dangerous, and so are frayed power cords, damaged or cracked wire insulation and broken plugs. They may result in a shock or fire hazard. Periodically examine the cord and have it replaced by your service technician if appearance indicates damage or deteriorated insulation.



7 Power-Cord Protection -- Power-supply cords should be routed so that they are not likely to be walked on or pinched by items placed upon or against them, paying particular attention to cords at plugs, convenience receptacles, and the point where they exit from the appliance.

8 Ventilation -- Slots and openings in the cabinet are provided for ventilation to ensure reliable operation of the video product and to protect it from overheating. These openings must not be blocked or covered. The openings should never be blocked by placing the video product on a bed, sofa, rug or other similar surface. This video product should never be placed near or over a radiator or heat register. This video product should not be placed in a built-in installation such as a bookcase or rack unless proper ventilation is provided or the video product manufacturer's instructions have been followed.

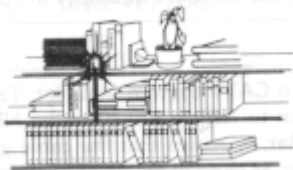

9 Attachments -- Do not use attachments unless recommended by the video product manufacturer as they may cause hazards.

Caution: Maintain electrical safety. Powerline operated equipment or accessories connected to this unit should bear the UL listing mark or CSA certification mark on the accessory itself and should not have been modified so as to defeat the safety features. This will help avoid any potential hazard from electric shock or fire. If in doubt, contact qualified service personnel.

10 Water and Moisture -- Do not use this video product near water - for example, near a bath tub, wash bowl, kitchen sink, or laundry tub, in a wet basement, or near a swimming pool, and the like.

11 Accessories -- Do not place this video product on an unstable card, stand, tripod, bracket, or table. The video product may fall, causing serious injury to a child or adult, and serious damage to the appliance. Use only with a cart, stand, tripod, bracket, or table recommended by the manufacturer, or sold with the video product. Any mounting of the product should follow the manufacturer's instructions, and should use a mounting accessory recommended by the manufacturer.

11A An appliance and cart combination should be moved with care. Quick stops, excessive force, and uneven surfaces may cause the appliance and cart combination to overturn.



12 Outdoor Antenna Grounding -- If an outside antenna or cable system is connected to the video product, be sure the antenna or cable system is grounded so as to provide some protection against voltage surges and built-up static charges. Section 810 of the National Electrical Code, ANSI/NFPA No. 70, provides information with respect to proper grounding of the mast and supporting structure, grounding of the lead-in wire to an antenna discharge unit, size of grounding conductors, location of antenna-discharge unit, connection to grounding electrodes, and requirements for the grounding electrode. See example below:

EXAMPLE OF ANTENNA GROUNDING

13 Power Lines -- An outside antenna system should not be located in the vicinity of overhead power lines or

IMPORTANT SAFETY INSTRUCTIONS FOR AC ADAPTER/CHARGER - 6 -

other electric light or power circuits, or where it can fall into such power lines or circuits. When installing an outside antenna system, extreme care should be taken to keep from touching or approaching such power lines or circuits as contact with them might be fatal. Installing an outdoor antenna can be hazardous and should be left to a professional antenna installer.

USE

14 Cleaning -- Unplug this video product from the wall outlet before cleaning. Do not use liquid cleaners or aerosol cleaners. Use a damp cloth for cleaning.

15 Object and Liquid Entry -- Never push objects of any kind into this video product through openings as they may touch dangerous voltage points or short-out parts that could result in a fire or electric shock. Never spill liquid of any kind on the video product.

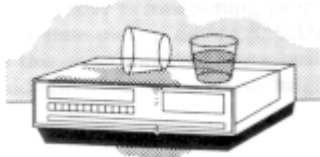

16 Lightning -- For added protection for this video product during a lightning storm, or when it is left unattended and unused for long periods of time, unplug it from the wall outlet and disconnect the antenna or cable-system. This will prevent damage to the video product due to lightning and power-line surges.



SERVICE

17 Servicing -- Do not attempt to service this video product yourself as opening or removing covers may expose you to dangerous voltage or other hazards. Refer all servicing to qualified service personnel.

18 Conditions Requiring Service -- Unplug this video product from the wall outlet and refer servicing to qualified service personnel under the following conditions.

- a. When the power-supply cord or plug is damaged
- b. If liquid has been spilled, or objects have fallen into the video product.
- c. If the video product has been exposed to rain or water.
- d. If the video product does not operate normally by following the operating instructions. Adjust only those controls that are covered by the operating instructions. Improper adjustment of other controls may result in damage and will often require extensive work by a qualified technician to restore the video product to its normal operation.
- e. If the video product has been dropped or the cabinet has been damaged.
- f. When the video product exhibits a distinct change in performance - this indicates a need for service.

19 Replacement Parts -- When replacement parts are required, have the service technician verify that the replacements he uses have the same safety characteristics as the original parts. Use of replacements specified by the video product manufacturer can prevent fire, electric shock or other hazards.

20 Safety Check -- Upon completion of any service or repairs to this video product, ask the service technician to perform safety checks recommended by the manufacturer to determine that the video product is in safe operating condition.

21 Heat -- The product should be situated away from heat sources such as radiators, heat registers, stoves, or other products (including amplifiers) that produce heat.

IMPORTANT SAFETY INSTRUCTIONS FOR AC ADAPTER/CHARGER

1. Save these Instructions -- This page contains important safety and operating instructions for AC Adapter/Charger Model VM-AC 85A.
2. Before using AC Adapter/Charger, read all instructions and cautionary markings on (1) AC Adapter/Charger, (2) battery and (3) product using battery.
3. Also read all instructions on pages 4 and 5.

4. Caution -- To reduce risk of injury, charge only rechargeable battery, VM-BP82G, VM-BP82 or VM-BP84. Other types of batteries may burst causing personal injury and damage.

5. Do not expose charger to rain or snow.
6. Use of an attachment nor recommended or sold by the battery charger manufacturer may result in a risk of fire, electric shock, or injury to persons.
7. To reduce risk of damage to electric plug and cord, pull by plug rather than cord when disconnecting charger.
8. Make sure cord is located so that it will not be stepped on, tripped over, or otherwise subjected to damage or stress.
9. Do not operate charger with damaged cord or plug - replace them immediately.
10. An extension cord should not be used unless absolutely necessary.
Use of improper extension cord could result in a risk of fire and electric shock. If extension cord must be used, make sure:
 - A. The pins on plug of extension cord are the same number, size, and shape as those of plug on charger.
 - B. That extension cord is properly wired and in good electrical condition; and
 - C. That wire size should be met below:
Minimum

AWG size	Length of extension cord (feet)
18	Equal to or less than 100
16	Equal to or less than 150
11. Do not operate charger if it has received a sharp blow, been dropped, or otherwise damaged in any way; take it to a qualified serviceman.
12. Do not disassemble charger: take it to a qualified serviceman when service or repair is required. Incorrect reassembly may result in a risk of electric shock or fire.
13. To reduce risk of electric shock, unplug charger from outlet before attempting any maintenance or cleaning.

Read This First

To guide you, we've included:

- A "Before You Begin" section containing important cautions for your family's safety as well as instruction for getting your video camcorder ready for use. Please read and understand this section thoroughly before moving on.
- A "Getting Started" section to familiarize yourself with the controls and prepare you for recording.
- A "Basic Techniques" section to allow you to use your video camcorder quickly and confidently before advancing to the more sophisticated features of the Hitachi VM-E220A.
- "Advanced Techniques" to help you with some of the exciting, sophisticated features of the Hitachi VM-E220A. We hope you will take the time to learn about these functions since they have been designed for you. You can use the video camcorder without reading this section.
- A "General Maintenance" section to help keep your purchase in good repair.

We want this manual to be as helpful as possible, so it includes two easy ways to find the information you need:

- A quick index for the information you use most often (this page).
- A detailed table of contents directing you to specific information quickly (page 10).

Get to know your video camcorder by using this manual, and get to know Hitachi. We appreciate your business.

Before You Begin

Any problems that occur as a result of any of the following conditions will not be covered by our warranty.

Be careful that no water, dust or sand enters the camcorder and all accessories.

When you shoot at a scene which contains an extremely bright object such as the sun or a light source, a bright vertical bar may appear in the picture.

Your camcorder is functioning properly, but the solid-state pickup device (C.C.D) usually causes this as an inherent characteristic. Try to avoid shooting an excessive bright object directly.

Be sure not to leave the camcorder in a place where the temperature exceeds 140°F (60°C), or the pickup device may be damaged.

Dangerous includes:

- Inside a car with the windows closed and in direct sunshine.
- Near heating appliances.

Do not leave the viewfinder lens facing sunlight for a prolonged period, or the phosphorescent surface of the cathode ray tube or the liquid crystal display (LCD) panel may be damaged.

Features

- Easy to use
- Instant zoom
- 24x zoom ratio
- Recorded date search
- Automatic title recording

Components and Accessories

Check that you have all the following components and accessories before proceeding.

1. Audio/Video output cable
2. Battery pack
3. AC adapter/charger
4. Batteries for date/title
5. DC cord
6. Lens cap string



Optional RF Adapter

If you wish to connect this camcorder to a television that does not have audio/video input jacks you will need to use the optional RF adapter model VM-RF86A (R).

The RF adapter can be purchased by calling the telephone number below. For your convenience Visa, Master Card, and American Express credit cards are accepted. The RF adapter can also be purchased by mail by sending either money order or your credit card information to the following address:

HiTRON, Inc.
675, Old Peachtree RD.
Suwanee, GA 30174
Tel: 1-800-995-4500

For more information concerning the purchase of camcorder accessories, please see the optional accessory listing on page 61.

Lens Cap

Using the lens cap string:

Pass the string through the lens cap and grip belt and attach it as shown in the figure.

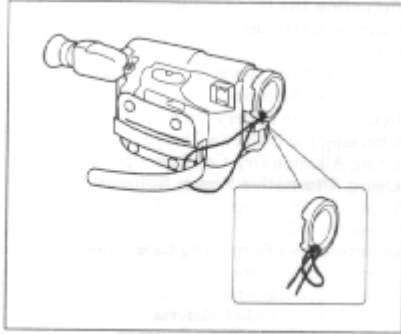

Removing the lens cap

Always attach the lens cap to protect the lens when carrying or storing the camcorder. During shooting attach the lens cap as shown in the figure to prevent it from being lost.

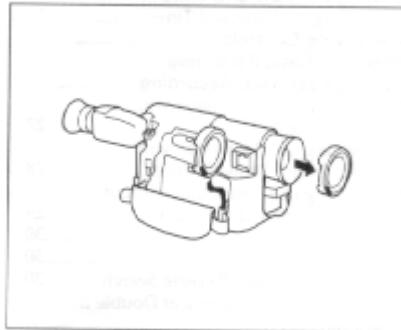

Getting Started

This section guides you through the initial preparation of the camcorder. None of these processes are complex. Set aside some time, relax, and familiarize yourself with this quality instrument.

Enjoy getting to know all about your Hitachi 8mm camcorder. The more comfortable and familiar you are with the machine and its features, the more you can make it do for you. Let's get started!

It is crucial that you read and understand all the safety instructions before you begin. If you haven't read the safety instructions yet, please take the time to do so now.

Charging the Battery

The first step is to set the battery to charge. It takes approximately an hour (VM-BP82G), enough time to familiarize yourself with some of the basic features of the camcorder. Once fully charged the battery will give an operating time of approximately 55 minutes, but this is reduced to a half to one-third depending on how often you use zoom and start/stop functions.

Charge the battery at a temperature range of 50°F(10°C) - 86°F(30°C) to prevent damage to the battery.

1. Plug the AC adapter/charger power cord into an AC outlet. Make sure that the wide blade fits into the wide slot. If it doesn't fit try reversing it. If you still cannot make fit the blades fully into the outlet either contact an electrician to replace your obsolete outlet, or use a polarized cord or outlet accessory.
2. To insert the battery into the charger align the reference arrow on the battery with the reference arrow on the AC adapter/charger. Push the battery till it is flush with the AC adapter/charger sliding it in the direction of the arrow as shown in the figure.
3. The CHARGE light remains on while the battery charges, turning off when charging completes.

Note: Remove the DC cord from the AC adapter/charger before attempting to charge the battery. The CHARGE light flashes if the DC cord remains connected while you attempt to charge the battery.

Note: Do not operate the battery at temperature below 14°F (-10°C) or above 95°F (35°C). At extremely low temperatures operation time decreases, while at high temperature the battery may be damaged.

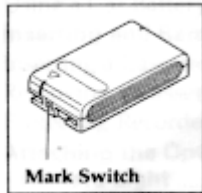

After charging set the mark switch to red so that you may quickly identify whether the battery is charged or uncharged.

Note: The marker switch does not guarantee the batteries charge status.

Additional Information

To use a battery in optimum condition:

- Use the battery until the low charge light () flashes. Using a battery for a short time and then recharging it may shorten the operation time.
- It is recommended to refresh a battery before recharging it when it has not been used for long time; otherwise its operation time becomes short. Press the refresh button.

After refreshing is complete, the REFRESH light turns off and the CHARGE light turns on and charging begins automatically.

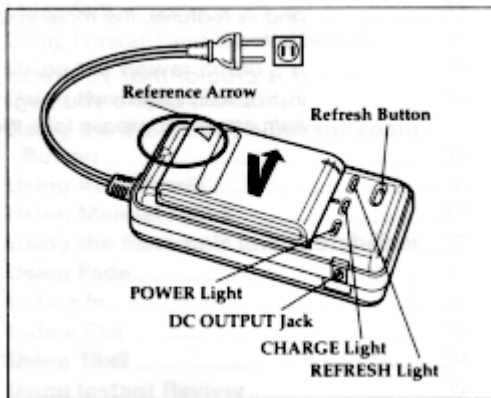

Refreshing a fully charged battery takes approximately 4 hours (VM-BP82G), adding considerable time to battery charging.

With repeated normal charging and use the battery will gradually lose operating time. When operation time becomes too short to be useful, replace the battery.

If the POWER light begins to flash during charging, remove the battery and then reattach it to the AC charger/adaptor. If the POWER light continues to flash after several attempts to attach it, the battery is unable to take a charge and must be replaced.

Do not attach a hot battery to the AC adapter/charger. Allow it to cool. Attaching a hot battery to the AC adapter/charger causes the POWER light to flash.

THERE ARE NO USER-SERVICEABLE PARTS INSIDE THE BATTERY OR AC ADAPTER/CHARGER.
THROWING THE BATTERY INTO FIRE OR EXPOSING IT TO EXCESSIVE HEAT (ABOVE 149°F [65°C]) MAY CAUSE INJURY.

SHORTING THE BATTERY'S TERMINAL INCREASES RISK OF FIRE OR ELECTRICAL SHOCK.

ATTENTION:

The product that you have purchased contains a rechargeable battery. The battery is recyclable. At the end of its useful life, under various state and local laws, it may be illegal to dispose of this battery into the municipal waste stream. Check with your local solid waste officials for details in your area for recycling options or proper disposal.



Ni-Cd

Adjusting the Electronic Viewfinder

The electronic viewfinder adjusts simply by pivoting it to a position where it is comfortable and easy to see through. Place the viewfinder back in its original position before storing the camcorder in its case or carrying the camera recorder around to avoid damaging the viewfinder or camcorder.

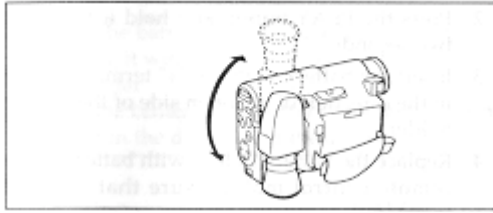

CAUTION:

Do not hold the unit by the electronic viewfinder when carrying as this could cause a malfunction.

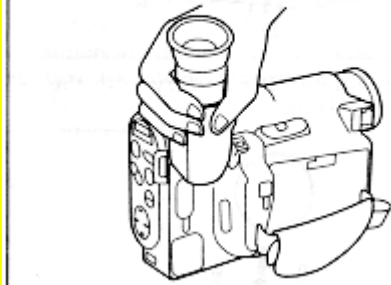

Eyepiece Adjustment

To use the electronic viewfinder, turn this control for your optimum focus adjustment.

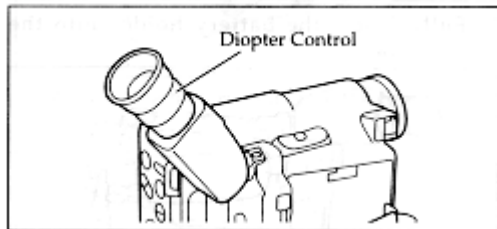

Adjustment the Hand Strap

Adjust the hand strap to best fit your hand. After adjustment, hook the hand strap's pad securely.

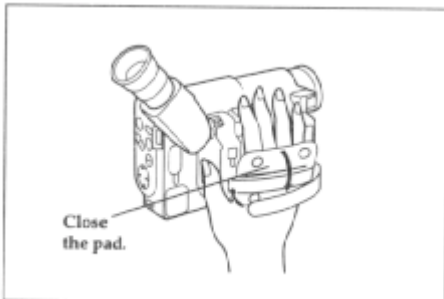

Loading Batteries

Clock Battery

Install the battery to prevent misplacing it.

1. Pull out the battery holder.

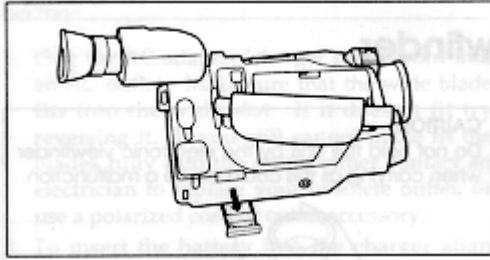

2. Insert the battery with the "+" terminal facing up.

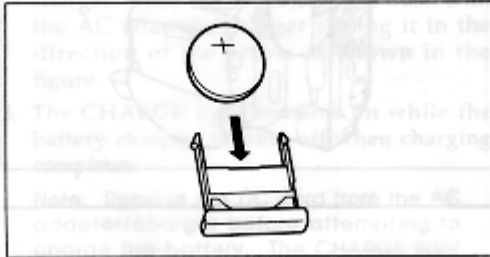

3. Fully insert the battery holder into the camcorder.

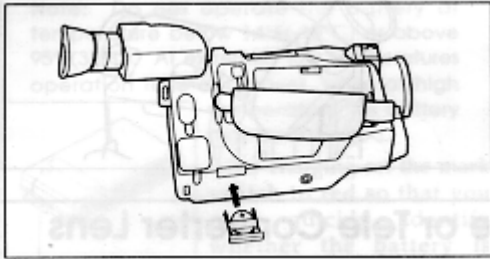

**WARNING: KEEP THE BATTERIES AWAY FROM CHILDREN AND PETS.
IF SWALLOWED CONSULT A PHYSICIAN IMMEDIATELY FOR EMERGENCY TREATMENT.**

Note: Replace the batteries with 3V micro lithium cells such as Maxell CR2025 or its equivalent.

Note: Dispose of battery safely in accordance with local laws. Do not dispose of in fire.

Note: Do not short circuit the batteries.

Note: Do not take apart the batteries.

Note: Do not hold the batteries with the metallic tweezers.

Note: Do not re-charge the batteries.

Note: Keep the batteries in a dark, cool, dry place.

Camcorder Batteries Using Battery Pack

Before you install the battery for the first time it must be fully charged. Refer to "Charging the Battery" on page 12 for details.

1. Lift the OPEN lever and pull it up. The power supply attachment cover will open.

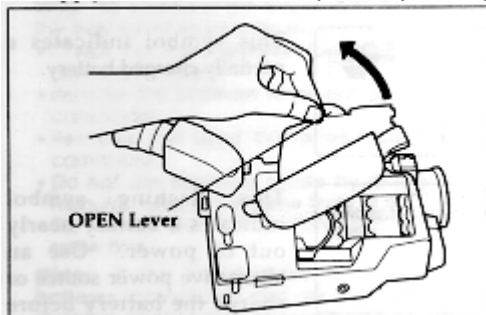

2. With the battery compartment facing you, align arrow on the battery with the arrow on the camcorder.

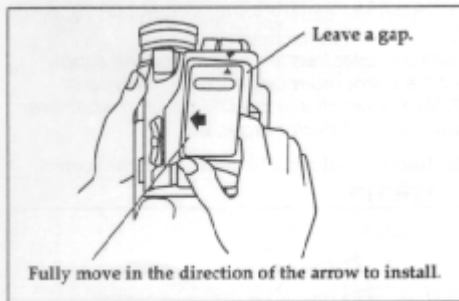

3. Once the arrows are aligned, push down on the battery.

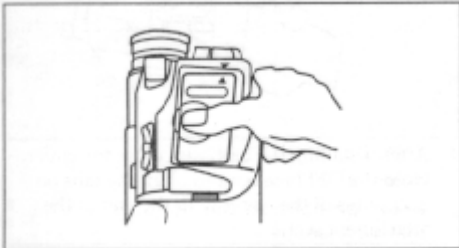

4. While pushing down the battery, slide it to the right until it "clicks" into place.



5. After installing the battery, close the cover. Hold the OPEN lever and align the tabs on both sides of the cover with the end of the attachment section.

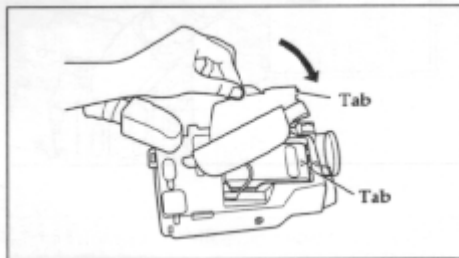

Note: If the OPEN lever is flat, the cover will not close.

Note: Always remove the battery from the camcorder after use.

Note: We cannot guarantee against malfunctions of the camcorder which occur when you use battery packs other than those specified.

Note: Always attach a battery by the procedure described here. Attaching a battery forcibly could damage it.

Removing the Battery Pack

1. Lift the OPEN lever and pull it up. The power supply attachment cover will open.
2. Push the side of the battery in the direction of the arrow. A click will be heard and the battery is released.

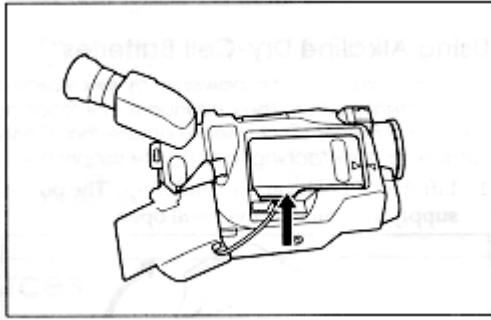

3. Remove the battery and close the cover.

Checking the Battery's Charge

A battery charge indicator is located on the upper right corner of the viewfinder. One of three symbols displays when the battery is used.

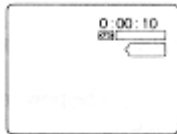
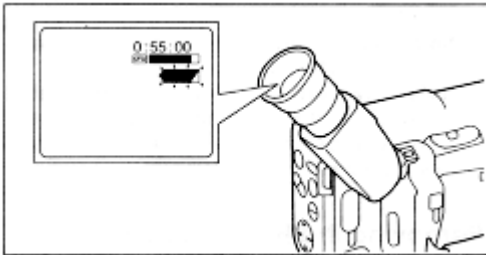

This symbol indicates a fully charged battery.



This symbol indicates a partially charged battery.

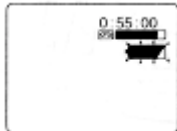

This flashing symbol indicates a battery nearly out of power. Use an alternate power source or charge the battery before continuing to use the camcorder.

Using Alkaline Dry-Cell Batteries

The camcorder can be powered by six alkaline dry-cell batteries inserted into the power supply attachment holder. The continuous operation time of the camcorder depends on the type of alkaline batteries used. Please ensure that CAM/OFF/VIDEO switch is in the OFF position whenever attaching or detaching any power supply (i.e. Battery, AC adapter/charger, etc.)

1. Lift the OPEN lever and pull it up. The power supply attachment cover will open.

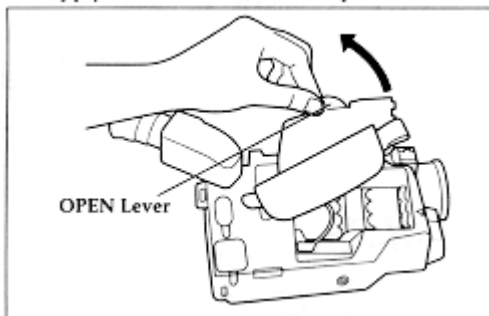

2. Lift the battery holder plates at the center of the attachment holder.

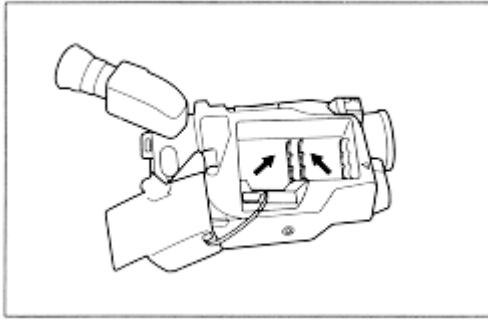

3. Insert six alkaline batteries with the correct polarities.

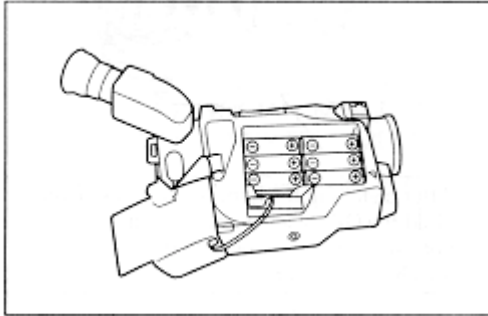

4. After installing the batteries, close the cover. Hold the OPEN lever and align the tabs on both sides of the cover with the end of the attachment section.

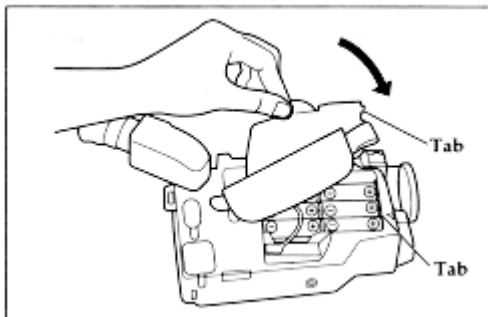

Note: Use only "AA" alkaline batteries marked "LR6". (Manganese batteries cannot be used to power the camcorder.)

Note: It is recommended that you use alkaline batteries within the recommended period of use or within two years of the date of manufacture.

Note: Be careful of the following to prevent the leakage of liquid or an explosion.

- Check that the orientation (polarity) of the batteries is correct.
- Remove the batteries when not using the camcorder.
- Remove the used batteries from the camcorder.
- Do not use batteries made by different manufacturers at the same time.
- Do not use old and new batteries at the same time.

Note: If the liquid leaks, remove the batteries immediately and ask your nearest dealer to inspect the camcorder (this will be at your own expense).

Note: Do not let the batteries or the terminals of the camcorder get dirty. If they are dirty, use a dry cloth to wipe off the dirt completely.

Note: It is recommended that you use a battery pack to power the camcorder when using a DC camera light. If a camera light is used when the camcorder is powered by batteries, the required supply voltage will be very short and the camcorder will turn off soon.

Note: When the batteries are used to power the camcorder in a cold place, it may not operate normally; the operation time may become extremely short or the camcorder may not be turned on. It is recommended that you use a battery pack to power the camcorder in a cold place. (At 50°F (10°C), the chemical reaction decreases the capacity of battery to one-tenth when compared to that at normal temperature 68°F (20°C).)

Note: Noise may appear momentarily in the viewfinder when recording is started or stopped.

Note: Be careful when touching the batteries with your bare hand to remove them as they are warm during and just use.

Note: Since the supply voltage from batteries decreases more abruptly when compared to that from a battery pack, the battery remaining level indicator () may not flash in the viewfinder, noise may occur, the picture and sound may not be recorded normally and/or the power may be turned off soon. These phenomena occur because the capacity of batteries becomes low. So turn the power switch off and replace the batteries. If the power switch is left turned on in this state, the power may turn on temporarily and turn off again repeatedly.

Note: Be sure not to short, disassemble, heat or throw batteries into fire. This is very dangerous.

Using Alternative Power Sources

Using the AC Adapter/Charger

Please ensure that the CAM/OFF/VIDEO switch is in the OFF position whenever attaching or detaching any power supply (ie. battery, AC adapter/charger, etc.)

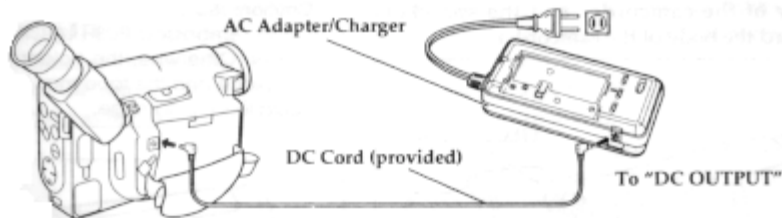

1. Plug the AC adapter/charger power cord into an AC outlet. Make sure that the wide blade fits into the wide slot. If it doesn't fit try reversing it. If you still cannot make fit the blades fully into the outlet either contact an electrician to replace your obsolete outlet, or use a polarized cord or outlet accessory.
2. Connect one end of the DC cord (provided) to the DC IN jack of the camcorder. Connect the other end of the DC cord to the DC OUTPUT of the AC adapter/charger.

Note: The AC adapter/charger can be used around the world. An AC plug adapter is required in some foreign countries. If you need one purchase it at your Hitachi distributor.

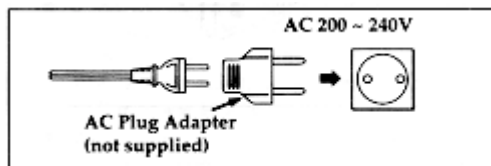

Note: The battery level indicator sometimes displays the partial charge symbol when using the AC adaptor/charger. Ignore this indicator when using the AC adaptor/charger.

Using a Car Battery

The camcorder can be powered with a car battery by using an optional car battery cord (Hitachi VM-CC80A) to plug the camcorder into the car's cigarette lighter socket. Please ensure that the CAM/OFF/VIDEO switch is in the OFF position whenever attaching or detaching any power supply (ie. battery, AC adapter/charger, etc.).

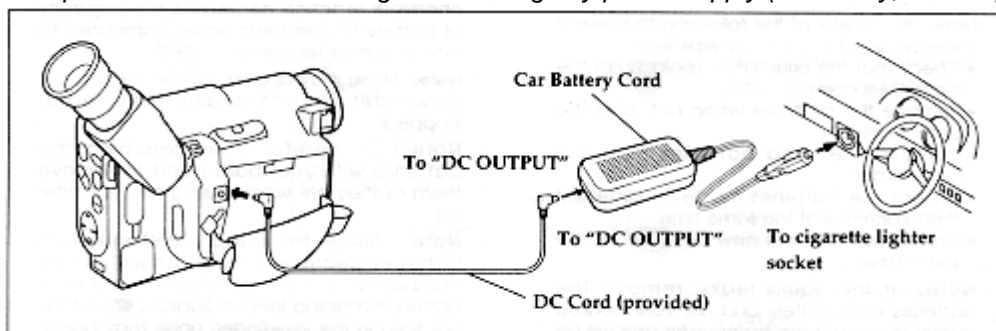

1. Plug the car battery cord into the car's cigarette lighter socket.
2. Connect one end of the DC cord (provided) to the DC IN jack of the camcorder. Connect to other end of the DC cord to the DC OUTPUT of the car battery cord.

Note: Only use the car battery cord with cars having 12/24 volt negative ground system.

Inserting and Removing Cassettes

A power source must be connected before inserting or removing cassettes. Once connected cassettes can be inserted or removed whether the CAM/OFF/VIDEO switch is on or off.

Inserting a Cassette

1. Slide the EJECT switch in the direction of the arrow. The cassette door opens automatically.
2. Place the cassette in the cassette holder so that the transparent window faces away from the body of the camcorder and the sprockets toward the body of the camcorder.

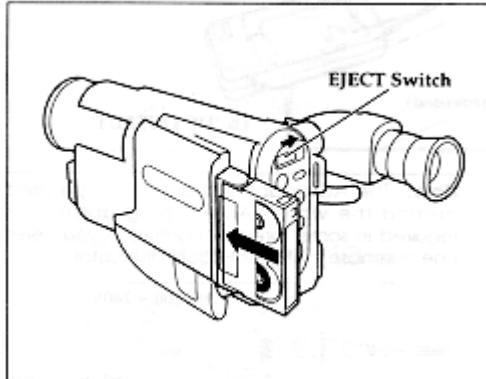

3. Push the cassette holder, which is embossed PUSH LOCK on the left hand side, until it "clicks" into place. The camcorder automatically closes.

Caution: Be sure that you push the cassette holder embossed PUSH LOCK to close the holder. Otherwise, the holder will not click into place and the tape may be slack which could lead to damage.

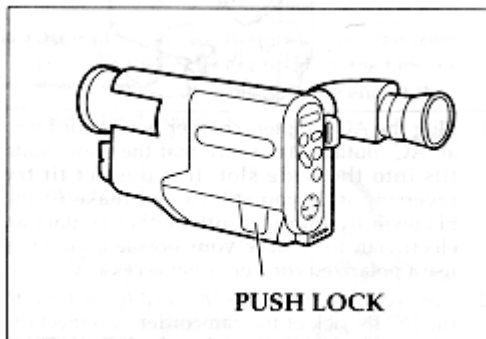

Note: If TAPE flashes in the viewfinder, remove the cassette and check that the tape is not damaged, is not slack or no dust adheres to it, etc. After making sure that there is no abnormality, reinsert the cassette. If TAPE reappears, see "Troubleshooting" on page 56.

Removing a Cassette

Slide the EJECT switch in the direction of the arrow. The cassette door opens automatically. Remove the cassette.

Protecting Recorded Material

Protect 8mm cassettes from accidental erasure by sliding the tab on the side of the cassette towards the opposite side until the tab is completely visible. Slide the tab in the opposite direction, until the tab disappears, to record on the cassette again.

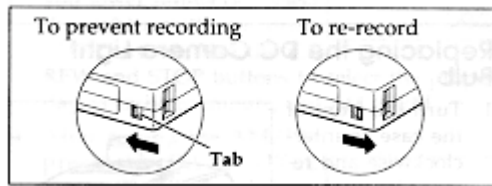

Using the Linear Time Counter

The linear time counter displays the tape run in hours, minutes, and seconds, helping you to keep track of how long you've been filming or time you have left to film before running out of tape.

Turn the camcorder on to display the linear time counter. The linear time counter keeps track from when you load a cassette into the camcorder and clears to 0:00:00 when the cassette is ejected.

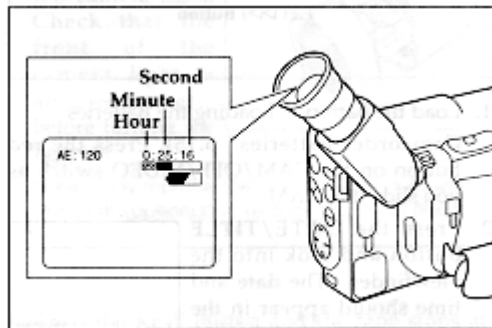

Remaining Tape

The tape remaining display shows the remaining tape that can be used for recording and playback, using seven dashes. This feature is handy when recording since it lets you know how long you can record on the loaded tape. Insert a cassette into the camcorder and start recording or playback; 10 seconds later, the remaining tape will be displayed. When the cassette is ejected, the display will disappear. " [Tape Icon] - - - - - " is displayed for 10 seconds after the tape starts to run.



Note: The tape remaining display appears 10 seconds after the tape starts to run.

Note: When the remaining tape time becomes less than about three minutes, TAPE END flashes in the viewfinder.

Setting the Date and Time

Take the time to set the date and time now. The date and time can be recorded on your tapes to act as a handy reference when viewing them later. Use the following procedure to set up the display for the current date and time.

Note: Be sure to insert the clock battery before setting the date and time. Although the date and time can be set without the clock battery inserted, they will disappear when the battery providing power to the camcorder is removed.

Make sure that the current time is displayed correctly before you start filming.

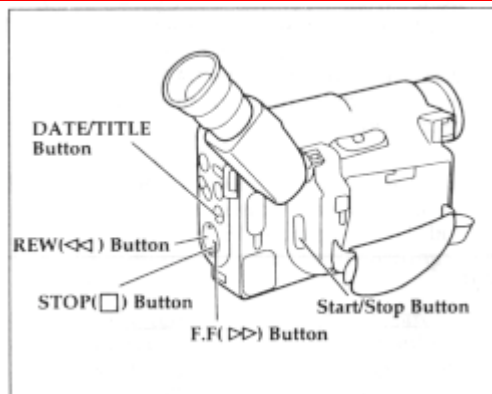

1. Load the battery ("Loading the Batteries: Camcorder batteries" p.15). Press the red button on the CAM/OFF/VIDEO switch as you slide it to CAM.
2. Press the DATE/TITLE button and look into the viewfinder. The date and time should appear in the lower right with the "1" flashing.

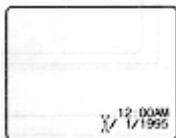

3. Pressing the F.F button gives you higher numbers while the REW button gives you lower numbers. Select the right month and press STOP button. Use the F.F, REW and STOP buttons to select the proper day, year, hour, minute, and AM or PM.

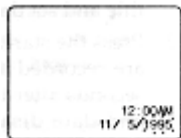

4. After setting the AM/PM, press the DATE/TITLE button. The display changes and the internal clock starts.



Note: After the date and time are set, " AUTO" appears and the camcorder enters the automatic date recording mode. See "Date Recording" on page 32.

Correcting the Date and Time

1. Press the DATE/TITLE button while pressing the STOP button. The flashing cursor appears at the month.
2. Move to where you need to make the correction with the STOP button and use the F.F and REW to correct.
3. Press the DATE/TITLE button to set the corrected date and time.

Getting Started, Identifying Controls

Left side/Rear Camera Illustration

1. Lens

F1.6 (4~48mm) 12:1 power zoom lens with auto focus and auto iris functions.

2. Viewfinder BRIGHT, COLOR and TINT controls

Refer to page 52.

3. Cassette Holder Close Button

CAUTION: Be sure to press this button to close the cassette holder. Otherwise, the tape may become slack and may be damaged.

4. Cassette Holder

A power source must be connected to the camcorder before a cassette can be inserted or removed.

5. Microphone**6. Record Indicator**

This indicator lights when the camcorder is recording.

7. Infrared Receiver

The area where infrared signals from the wireless remote are received. Aim the remote control to this area for best results.

8. EJECT Switch

A power source must be connected before cassettes can be inserted or removed though the CAM/OFF/VIDEO switch may be set to OFF ("Inserting and Removing Cassettes," p.18).

9. DATE/TITLE (DISP.) Button

Use this button to record the date, time and title on your tape. Any time that the date, time and title displays appear in the viewfinder, they are recorded on your tape. (This button can be used instead of DISPLAY button on the remote control in the VIDEO mode.)

Note: Be sure to insert the clock battery before setting the date and time or creating a title.

12. Ring of Tape Transport

▶▶ - F.F Button

Use this button to fast forward tapes or for visual search. During visual search the camcorder fast forwards at approximately 9 times normal playback speed. Also use this button to set date and time.

- STOP Button

Use this button to stop playback, fast forward, or reverse. Also use this button to set date and time.

◀◀ - REW Button

Use this button to fast rewind tapes or for visual search. During visual search the camcorder rewinds at approximately 7 times normal playback speed. Also use this button to set date and time. Furthermore, use this button to review the last few seconds of the tape you are recording.

▶ - PLAY Button

Use to playback recorded tapes.

Right side/Battery cover Illustration

11. FOCUS Control Buttons

Press these buttons simultaneously to select manual or automatic focus. For manual focusing ("Using Manual Focus", p. 35), press the F or N buttons to bring the subject into focus. When using manual focus, FOCUS appears in the viewfinder.

12. Diopter Control

To use the electronic viewfinder, turn this control for your optimum focus adjustment.

13. CAM/OFF/VIDEO Power Switch

Hold down the red button as you slide the switch to CAM or VIDEO. You do not need to hold down the red button to slide the switch to OFF.

14. INST. ZOOM (Instant Zoom) Button

Use this button to magnify the image being recorded 1.5 times.

15. Power Zoom Switch

Use this to zoom automatically ("Using the Power Zoom," p.33).

16. Camera Light Shoe

Attach the DC camera light here.

17. OPEN Lever

Use this to open or close the cover of the power supply attachment holder ("Camcorder Batteries", p15).

18. Power Supply Attachment Section (Behind the cover)

Attach a battery or alkaline batteries here ("Camcorder Batteries", P.15, 16).

19. Hand Strap

Refer to page 13.

20. DC IN Jack (Behind the jack cover)

When using the AC adapter/charger, connect one end of the DC cord (provided) to this jack and the other end to the DC OUTPUT jack of the AC adapter/charger. When using the car battery cord (optional), connect this jack and the DC OUTPUT jack of the car battery cord.

21. Start/Stop Button

When the CAM/OFF/VIDEO switch is in CAM press this button to start recording. When pressed a second time the camera pauses. During playback use this button to stop the tape temporarily. Pressing a second time resumes normal playback.

Right side/Jack covers/Underside Illustration

22. AV IN/OUT Jack (Behind the jack cover)

Use this jack to connect the camcorder to a VCR or television ("Connecting to a Television without Audio In and Video In Jacks", P.28).

23. AV OUTPUT Jacks (Behind the jack cover)

Use this jack to connect the camcorder to a VCR or television ("Playing Back Your Recording", p.26, 27, "Dubbing from the Camcorder to a VCR", p.38, "Recording Television Programs", p.39).

24. Shoulder Strap Slots

Attach a shoulder strap here.

25. Clock Battery Compartment

Pull the battery holder and install the clock battery (provided).

26. Tripod Mounting Threaded Socket

Use this threaded socket to mount the camcorder to a tripod.

Basic Techniques

The batteries are in place and charged, the date and time are set, and you are familiar with the controls. It's time to make a recording. Basic recording is easy and simple. Hooking up the camcorder to your TV is not complicated but give yourself plenty of time to ensure connections are correct.

This section guides you through basic recording and playback. Practice the basic techniques of recording and playback on something unimportant such as traffic or a short tour of your backyard. Once familiar with how the machine works you can move to the more sophisticated features with less stress.

Let's get started!

Making a Basic Recording

The Hitachi VM-E220A uses PROGRAM AE auto exposure that automatically selects the optimum shutter speed (either 1/60, 1/120, 1/180, 1/250, 1/350, 1/500, 1/750, 1/1000, 1/1500, 1/2000, or 1/4000 of a second). The iris adjusts automatically in response to shutter speed.

1. Connect the camcorder to a power source ("Loading Batteries; Camcorder Batteries," p 15, "Using Alternative Power Sources," p.17).
2. Insert an 8mm cassette ("Inserting and Removing Cassettes," p.18).
3. Press the red button on the CAM/OFF/VIDEO switch as you slide it to CAM. ■ appears and the camcorder is now ready to record.

CAM/OFF/VIDEO Switch

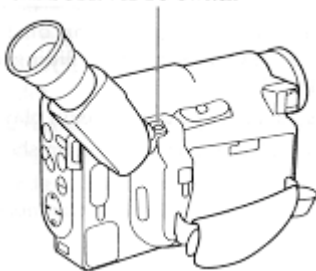

4. Use the diopter control to match the viewfinder's focus with your eyesight.
5. When you are ready to record press the Start/Stop button. REC appears in the viewfinder and the camcorder records the picture you see in the viewfinder.

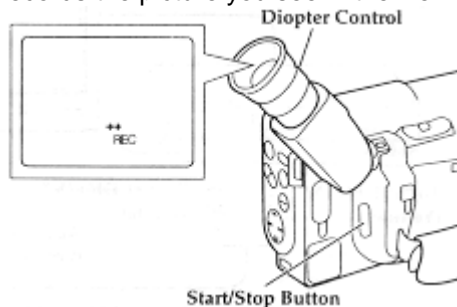

Note: TAPE flashes in the viewfinder when the tab on the side of the cassette is completely visible.

6. To stop recording press the Start/Stop button and *REC* disappears from the viewfinder replaced by **II**. This places the camcorder in standby.

Note: TAPE END flashes in the viewfinder when about 3 minutes or less remain of the tape cassette.

Note: If the camcorder is left in record/pause mode for more than 5 minutes, the camcorder turns off automatically. To restart it press the Start/Stop button and the camera returns to record/pause mode.

Playing Back Your Recording

Depending on the setup of your video equipment, you connect the camcorder in one of the 3 methods explained below.

Connecting to a Television with a VCR Attached

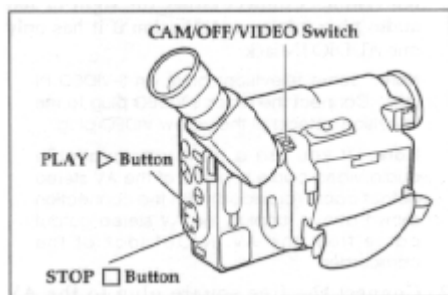

1. Connect the provided audio/video output cable to the AUDIO IN and VIDEO IN jacks of your VCR.

Note: If your VCR has two (stereo) AUDIO IN and VIDEO IN jacks, connect the audio plug to the left-channel AUDIO IN jack.

2. Connect the free square plug to the AUDIO OUT and VIDEO OUT jacks of the camcorder.
3. Insert a previously recorded cassette into the camcorder.
4. Turn on your VCR and place it in the camcorder input mode (consult your VCR manual for details). Operate the television as you normally do to see the signal coming from the VCR.
5. Hold down the red button on the CAM/OFF/VIDEO switch while sliding the switch to VIDEO.
6. Press the PLAY button to begin playback.
7. Press the STOP button when finished.

Connecting to a Television with Audio In and Video In Jacks

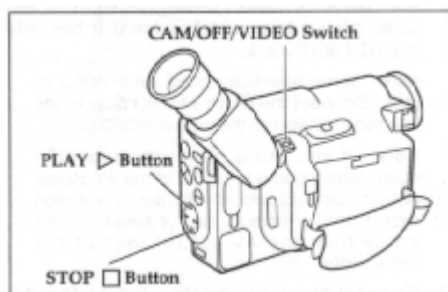

1. Connect the provided audio/video output cable to the AUDIO IN and VIDEO IN jacks of your television.

Note: If your television has two (stereo) AUDIO IN and VIDEO IN jacks, connect the audio plug to the left-channel AUDIO IN jack.

2. Connect the free square plug to the AUDIO OUT and VIDEO OUT jacks of the camcorder.
3. Insert a recorded cassette into the camcorder.
4. Turn on your television and set to the camcorder input mode (consult your television manual for details).
5. Hold down the red button on the CAM/OFF/VIDEO switch while sliding the switch to VIDEO.

6. Press the PLAY button to begin playback.
7. Press the STOP button when finished.

Connecting to a Television without Audio In and Video In Jacks

1. Disconnect the VHF antenna leads from the back of the television. Leave the UHF antenna leads connected.
2. Connect the VHF antenna lead to ANT IN of the RF output adapter. If the cable on the VHF antenna lead is flat you need to purchase an antenna adapter (300-ohm to 75-ohm transformer). Connect the antenna adapter to the VHF antenna lead and slide the adapter on to the ANT IN terminal.
3. Connect the 75-ohm coaxial cable of the RF output adapter to the VHF antenna terminals on the back of the television. If the television is set up to connect to a flat antenna lead you need to purchase antenna adapter (75-ohm to 300-ohm transformer). Connect the adapter to the 75-ohm coaxial cable of the RF output adapter and connect the free ends of the adapter to the VHF antenna terminals at the back of your television.
4. Connect the RF output adapter cable to the AV IN/OUT jack of your camcorder.
5. Turn your television on and select channel 3 (channel 4 if channel 3 is a channel used in your area).
6. Select the CH3 or CH4 on the RF output adapter matching the channel selected on your television.
7. Insert the previously recorded cassette into the camcorder.
8. Hold down the red button on the CAM/OFF/VIDEO switch while sliding the switch to VIDEO.
9. Press the PLAY button to begin playback.
10. Press the STOP button when finished.

Simple Playback (Using the Electronic Viewfinder)

1. Insert the cassette ("Inserting and Removing Cassettes," p.18).
2. Hold down the red button on the CAM/OFF/VIDEO switch while sliding the switch to VIDEO.
3. Press the PLAY button and enjoy your video.
4. Press the STOP button when finished.

Using Still

To view a still picture during playback press the Start/Stop. Press the Start/Stop button again to resume playback. If you leave the camcorder in play/pause mode for more than 5 minutes the camcorder automatically stops the cassette to prevent damage to the tape.

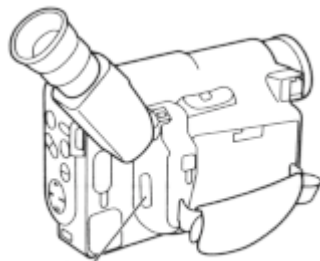

Start/Stop Button

Note: When you engage play/pause mode the still picture will have some interference or noise. This is normal.

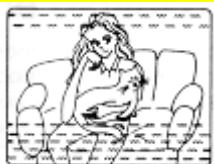

Using Forward and Reverse Search

When looking for a particular point in your videotape use the F.F button and REW button to find the spot quickly.

- Press F.F button during playback to play the tape forward at approximately 9 times normal speed. Press PLAY button to return to normal playback.
- Press REW button during playback to play the tape backwards at approximately 7 times normal speed. Press PLAY button to return to normal playback.

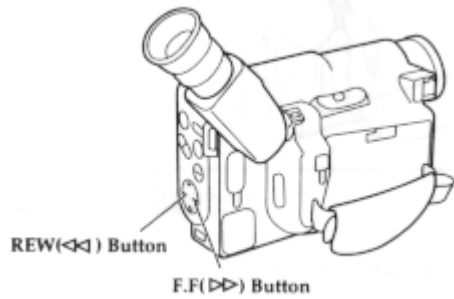

Note: When you engage F.F button or REW button the picture will have some interference or noise. This is normal during search mode.



To Play Back a Recording at Double the Normal Speed

Activate the video playback mode by moving the CAM/OFF/VIDEO switch to "VIDEO". Press the PLAY button located on either the remote control or the camcorder one time and the video will appear in the viewfinder or a connected monitor. While the tape is playing press the PLAY button again and the camcorder will now play both audio and video at double speed.

To restore normal playback, press the PLAY button on either the remote control or the camcorder.

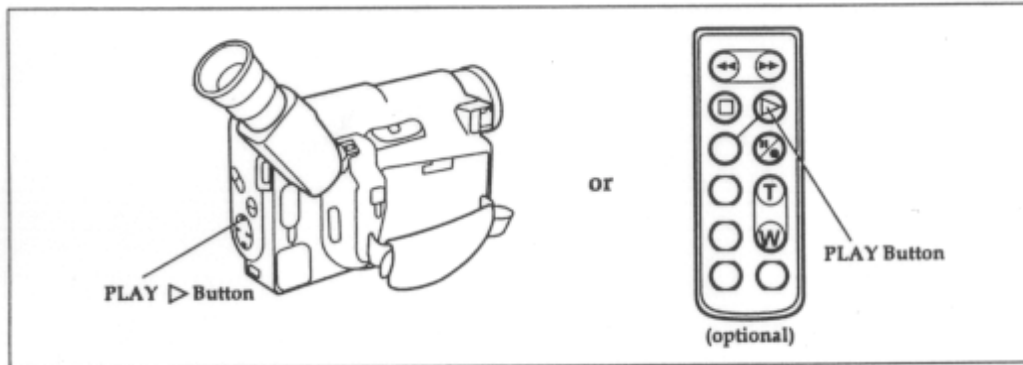

Note: The indication showing double speed playback does not appear.

Note: When double speed playback is activated, both the picture and sound are played back at twice the normal speed. This will cause noise lines to appear on the picture and the sound to become warbled. (With some tapes the width of the noise band may vary or noise may flow.)

Note: With some TVs, the synchronization may unlock and the picture may fluctuate or the picture may become black-and-white.

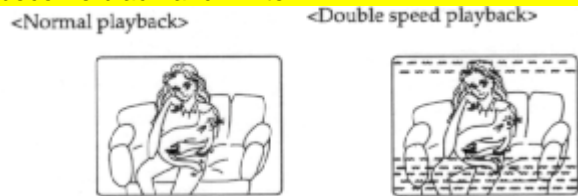

Advanced Techniques

The Hitachi VM-E220A offers a diverse group of features that add interest and excitement to your video. iiAdding fades to smooth transitions creates video with a professional look.

As you learn and practice with these features think of situations that they might fit in and add a special touch.

Date Recording

When the date has been set, the camcorder will enter the automatic date recording mode automatically.

1. Press the red button on the CAM/OFF/VIDEO switch as you slide it to CAM.
2. Press the DATE/TITLE button to specify the date display you want to record.

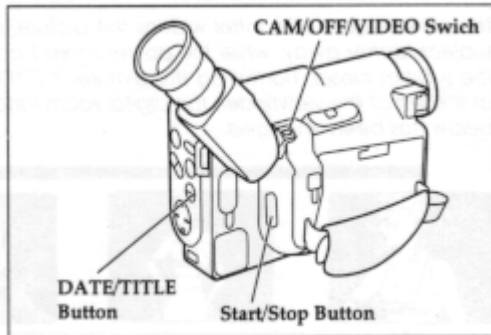

AUTO and Date - Automatic Date Recording

This option records the date automatically once a day at the beginning of recording for ten seconds

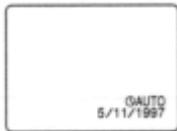

Note: The camcorder records the same date when;

- the cassette is replaced.
- you select AUTO and date display again.
- the recording is less than 10 seconds long.

Note: If the date changes while recording continues over 10 seconds, the new date is recorded for about 10 seconds the next time you make a recording.

TITLE and Date - Automatic Title and Date Recording

This option records the date and created title (see "Creating and Recording a Title" on page 43) automatically once a day at the beginning of recording for 10 seconds.

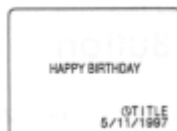

Note: When TITLE is displayed in the viewfinder, the title cannot be turned on or off using the remote control.

Date - Date Recording

The camcorder records the date with the picture all the time.



No Display - No Date Recording

The camcorder does not record the date.

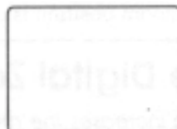

Date and Time - Date and Time Recording

The camcorder records the date and time with the picture all the time.



3. Press the start/stop button. Recording will start.

Note: When AUTO and date display is selected, the date disappears about 10 seconds after recording is started.

Note: When TITLE and date display is selected, the title and date disappear about 10 seconds after recording is started.

Using the Power Zoom

The power zoom W control widens the picture, moving the subject farther away, while the power zoom T control brings the subject closer, narrowing the picture. If ZOOM appears at the left of the viewfinder, the digital zoom function shown below has been engaged.



When the power zoom switch is operated, the zoom position is displayed in the viewfinder for about 5 seconds and then disappears. The zoom position is displayed in 10 steps.

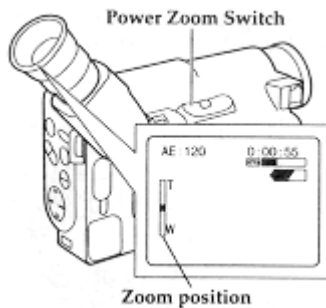

Using the Digital Zoom

The digital zoom increases the magnification of the power zoom by 2 times. You must place the subject you wish to magnify at the center of the viewfinder.



Note: This digital zoom has certain limitation and may degradate at extreme magnification and amplify camcorder's movement.

Press and hold the power zoom T control until you find the picture you want. You control the zoom with the power zoom T and W controls. When ZOOM is not displayed in the viewfinder, normal zoom functions resume.

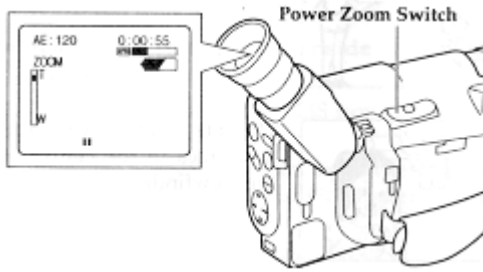

Using the INST. ZOOM (Instant Zoom) Button

The instant zoom feature activates the digital zoom to magnify the subject 1.5 times regardless of zooming engaged by the power zoom T and W controls.

Press the INST. ZOOM button. I. ZOOM appears at the left of the viewfinder and the picture is magnified 1.5 times.

Note: To return to the original zoom position, press the INST. ZOOM button so that I. ZOOM disappears from the viewfinder.

Note: This instant zoom has certain limitations and may degrade at extreme magnification and amplify camcorder's movement.

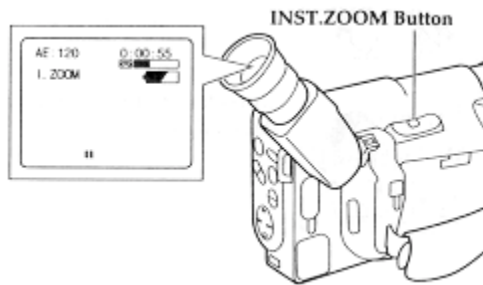

Using Auto Focus

The camcorder focuses the subject in the center of the viewfinder automatically unless the manual focus is engaged. If FOCUS appears in the viewfinder, manual focus is engaged. Press the FOCUS control buttons simultaneously to return to auto focus.



Good



No good

The auto focus will not work under the following conditions and you must focus manually:

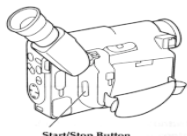

Start/Stop Button

Objects outside the center of the viewfinder



Objects at different distances in the center of the viewfinder



Brightly lit objects such as a neon light, objects lit by spotlight, etc.

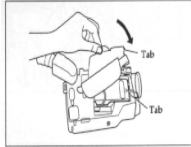

Objects behind water dappled or dusty glass

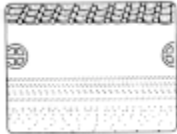

Objects with little difference in light reflection such as a white wall



Rapidly moving objects



Dark objects

Note: With the T zoom control you can use the auto focus with subjects that are 3.3 feet (100cm) away from the lens and further away to infinity. With the W zoom control you can use the auto focus with subjects 3/8 inches (1cm) away from the lens and further away to infinity.

Using Manual Focus

1. Press the FOCUS control buttons simultaneously. FOCUS displays in the viewfinder. You can adjust the focus manually.
2. Use the power zoom T control to zoom up completely to your subject. If you don't use the T control to zoom to the picture you want, the picture may fall out of focus when actual recording starts.
3. Press the Focus control F (far) or N (near) button until the subject is in focus.
4. Use the power zoom W control to zoom back to the picture you desire.

Note: To return to auto focus press the FOCUS control buttons and the FOCUS disappears from the viewfinder.

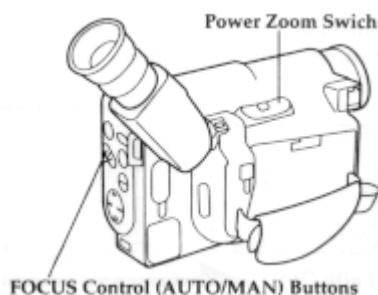

Using Instant Review

Use this feature to view the last few seconds of the tape you shot.

1. Set the camcorder to record/pause mode and tap the REW button. The last few seconds of tape play back in reverse and then in normal playback mode.
2. The camera plays back to the spot where you paused and returns to record/pause mode (standby). Press the

Start/Stop button to resume recording.

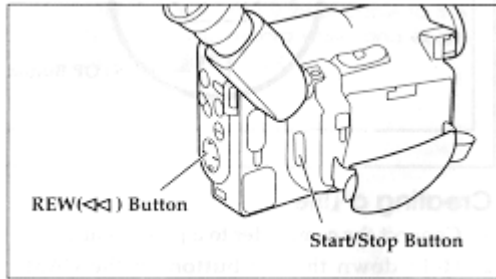

Using Quick Edit

Use quick edit to search for the end of previously recorded material, find a particular spot on your tape, begin editing, or record new material. While the camera is in record/pause mode hold down the F.F, REW, or PLAY button and visually search the tape. Release the button and the camcorder stops the tape at the exact position you selected.

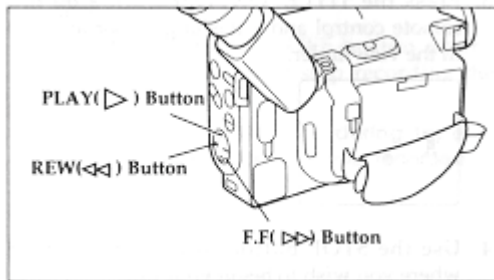

Using Macro

This function allows you to shoot subjects as close as 3/8 inches (1cm). Press and hold the power zoom control W. The camera focuses on the subject automatically. Check your lighting as it tends to be insufficient when filming close up.

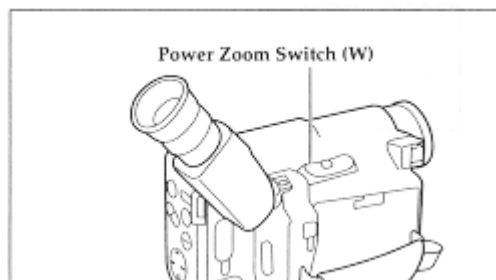

Date Search

The date search function memorizes the start and end positions of recordings you made on a specific day so you can easily locate those positions later as long as the cassette is left in the camcorder.

Note: Be sure that the date and time are set.

1. Attach a power source and slide the CAM/OFF/VIDEO switch to VIDEO.
2. Press the DATE/TITLE button (the DISPLAY button on the remote control) to display "SEARCH" in the viewfinder.



3. Press the REW button to search for the start position from which you last made a recording or the F.F button

(the F.FWD button on the remote control) to recording end position.

4. When the required position is located, the camcorder enters the stop mode and "SEARCH" disappears from the viewfinder.



Note: If you have ejected the cassette, this function will not operate with that cassette. (When a cassette is inserted and the recording is started, the position is identified as the recording start position on that day.)

Note: If the date/title battery is not inserted, the date search function does not operate when the battery providing the power to the camcorder is removed.

Note: When the cassette was recorded by another camcorder, the date search function does not operate.

Note: The date search function is released when you press the STOP button during date search mode.

Note: If the recorded time is less than 30 seconds, the date search function may not operate normally.

Dubbing from the camcorder to a VCR

Connect the camcorder to a VCR to copy your or a friend's home 8mm recordings to VHS.

Camcorder to VCR Connection Illustration

1. Connect your camcorder to the VCR, following "Playing Back Your Recording" on page 26.
2. Turn on your VCR and place it in the camcorder input mode (consult your VCR manual for details). Operate the television as you normally do to see the signal coming from the VCR.
3. Hold down the red button of the CAM/OFF/VIDEO switch while you slide the switch to VIDEO.
4. Insert the recorded tape in the camcorder and a blank tape into the VCR. Set the VCR to record.
5. Play the tape from the camcorder while recording on the VCR.

Note: If the VCR is connected to a television and the VCR/TV selector is set to VCR, you can monitor the tape being dubbed.

Recording Television Programs

If your television or VCR has AUDIO OUT and VIDEO OUT jacks you can record television programs with your camcorder.

Recording Television Programs Illustration

1. Connect the optional AV input cable to the VIDEO OUT and AUDIO OUT jacks of your television or VCR.
2. Connect the free plug to the AV IN/OUT jack of your camcorder.
3. Connect the camcorder to a power source.
4. Insert a cassette in the camcorder.
5. Hold down the red button on the CAM/OFF/VIDEO switch while sliding the switch to CAM.
6. Turn your television or VCR on and tune it to the channel you wish to record from.
7. Press the Start/Stop button to start recording the program that is on the screen of the television.
8. Press the Start/Stop button again to stop recording.

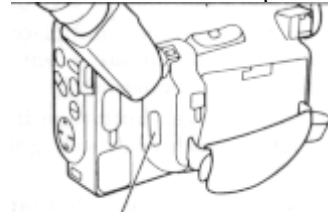

Start/Stop Button

Note: If the tape is played back while the AV input cable is left connected to the camcorder, noise may appear in the picture. In this event, press the STOP button to stop the camcorder, unplug the AV input cable and play back the tape again.

Note: To monitor the picture being recorded, connect the AV Stereo Output Cable (provided) to the VIDEO IN jack of the television as shown above.

Using the Optional Wireless Remote Control

Loading the Optional Remote Control Battery

1. Push the tab to the left of the remote control and hold it, then remove the battery holder.

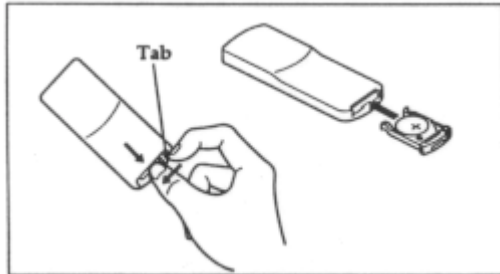

2. Insert the battery with "+" terminal facing up as shown in the figure.
3. Replace the battery holder with battery in the remote control making sure that it is fully inserted.

Identifying Controls

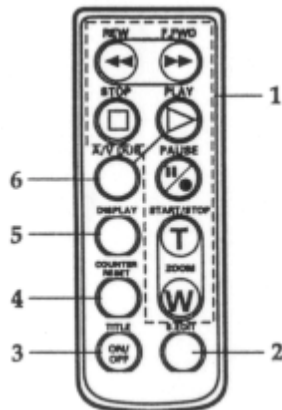

1. Recorder's Remote Control

The shaded buttons on the remote control have the same functions as the corresponding buttons on the camcorder.

2. S.EDIT (Synchro Edit) Button (only on the remote control)

Use this button to activate the synchro edit function for dubbing ("Using Synchro Edit", P.46).

3. TITLE ON/OFF Button (only on the remote control)

Use this button to create and record titles for your tapes ("Creating and Recording a Title," p.43).

4. COUNTER RESET Button (only on the remote control)

Use this button to reset the linear timer counter to 0:00:00.

5. DISPLAY Button

Use this button to select the viewfinder and TV display ("Using the Display Button," p.42). This button can be used instead of the DATE/TITLE button on the camcorder in the VIDEO mode.

6. A/V DUB BUTTON (only on the remote control)

Use this button to record new audio and video over existing audio and video.

Remote Control Range

Use the wireless remote control to operate the camcorder from a distance. The PLAY, F.FWD, REW, STOP, PAUSE (START/STOP) and ZOOM buttons on the wireless remote control operate the functions of the corresponding buttons on the camcorder. Aim the wireless remote control at the infrared receiver of the camcorder.

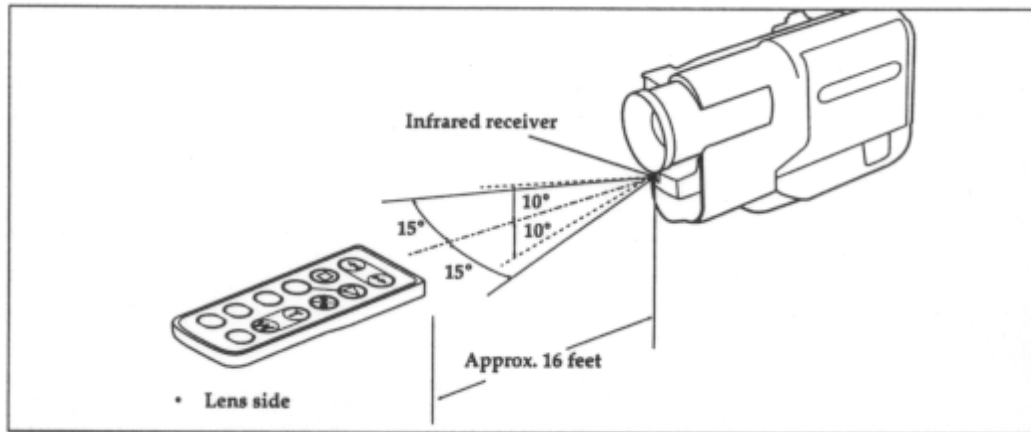

Note: Use the wireless remote control within the range of the infrared receiver of the camcorder shown above.

Note: The wireless remote control may not function in strong light such as direct sunlight or very bright artificial lighting.

Note: Clear a direct path from the wireless remote control to the infrared receiver. The wireless remote control won't work if an obstacle blocks the infrared rays.

Note: The remote control code of this camcorder is Hitachi code VCR2. If you have a VCR with the same code your Hitachi VCR may malfunction when you use the camcorder's wireless remote control.

How to attach the optional remote control holder to a generally available shoulder strap

It is recommended that you fit the remote control into the holder and attach the holder to the shoulder strap so as not to lose the remote control and for convenience when shooting outdoors.

1. Attach the holder to the shoulder strap.

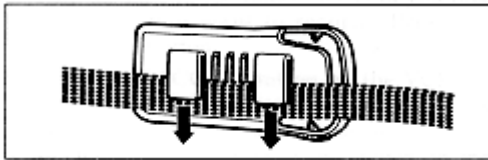

2. Attach the remote control to the holder. Fit the remote control into the holder as shown in the figure below and push until a click is heard.

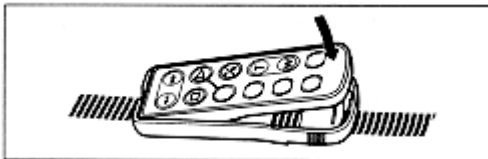

To remove the remote control

Push both sides of the holder until the remote control is released from the tab. The rear of the remote control will be released from the holder and will lift slightly.

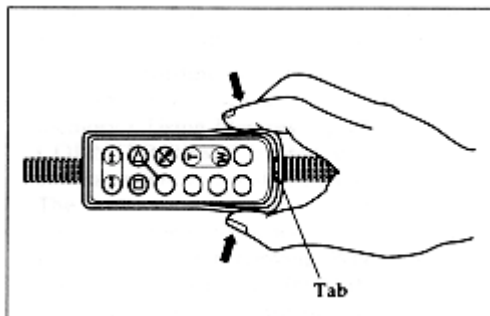

Using Memory

The linear time counter memory stops a rewinding tape at approximately 0:00:00M. This feature helps in locating a specific point in the tape to which you wish to return. An example might be that you have recorded some tape that you have already watched, you continue recording but do not care to watch the tape you recorded earlier. The memory feature returns you to the beginning of the most recent recording.

1. Press the DISPLAY button on the remote control so the linear time counter with memory is displayed as shown in the figure.
2. Start recording or playback of a cassette. Press the COUNTER RESET button on the remote control at the point to which you wish to return. The linear time counter clears to 0:00:00M.
3. Press the STOP button to stop playback, or press the start/stop recording and set the CAM/OFF/VIDEO switch to VIDEO.
4. Press the REW button and the tape stops at approximately where you reset the linear time counter. This feature works in F.F as well.

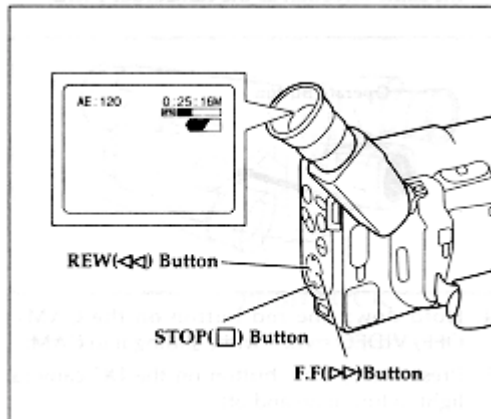

Using the Display Button

Pressing the DISPLAY button on the remote control allows you to switch the displays in the viewfinder. When the camcorder is turned on, the linear time counter appears.

- Pressing the DISPLAY button once displays the linear time counter with the memory feature.

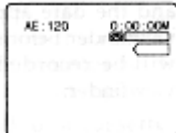

- When a recorded tape is in the camcorder during the VIDEO mode, "SEARCH" appears in the viewfinder. (Refer to "Date Search" on page 37).
- Pressing the DISPLAY button a second time returns to the linear time counter.

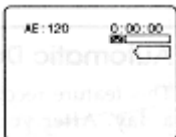

Note: The linear time counter with the memory feature in the viewfinder can also be displayed on the connected television.

Creating and Recording A Title

Create titles easily and personalize your recordings while keeping a permanent visual record of what is contained on a tape. The camcorder can store a title in its memory. A title stored in memory can be displayed and recorded at any time. A title contains two lines of up to 16 characters per line. The camcorder contains 47 different characters for creating a title. When creating and recording a title, use the TITLE ON/OFF button on the remote control.

Note: When creating a title in the CAM mode, the DATE/TITLE button of the camcorder can be used instead of the TITLE ON/OFF button on the remote control. " TITLE" should be displayed in the viewfinder at this time.

Note: Be sure to insert the clock battery before creating a title. Although a title can be created without the clock battery inserted, it will disappear when the battery providing power to the camcorder is removed.

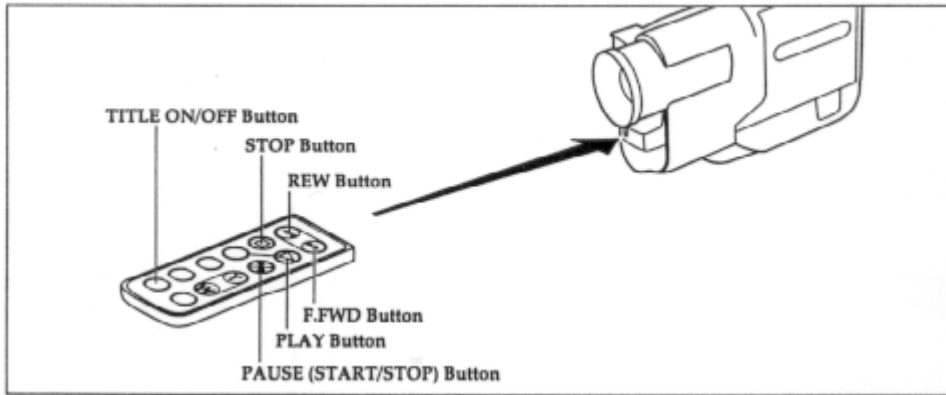

Creating a Title

1. Connect the camcorder to a power source.
2. Hold down the red button on the CAM/OFF/VIDEO switch and slide it to either CAM or VIDEO.
3. Press the TITLE ON/OFF button on the remote control and a flashing cursor appears in the viewfinder.



4. Use the STOP button to place the cursor where you wish to begin your title.
5. Use the F.FWD and REW buttons to select the first character of your title.

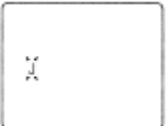

Characters available for your title.

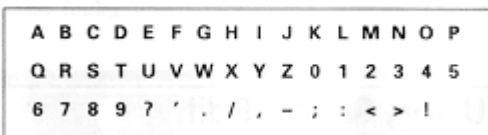

6. Once you've selected a character press the STOP button to set it.

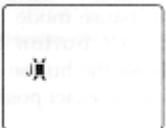

7. Complete the title by repeating steps 5 and 6.

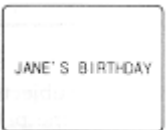

8. When you complete your title, press the TITLE ON/OFF button on the remote control to store the title in memory and remove the title graphics from the viewfinder.

Note: As long as the correct current time can be displayed, the title is held in memory.

Correcting Errors

1. Press the TITLE ON/OFF button on the remote control or the DATE/TITLE button on the camcorder.
2. Use the STOP button to select the character to be corrected.
3. Use the F.FWD or the F.F (on the camcorder) and REW buttons to correct the character.
4. Press the TITLE ON/OFF button on the remote control or the DATE/TITLE button on the camcorder to store the corrected title in memory.

Recording Title on a Tape in the Camcorder

1. Hold down the red button on the CAM/OFF/VIDEO switch while sliding the switch to CAM.
2. Locate the point of the tape where you wish to record the title ("Using Quick Edit," p.36).
3. Press the TITLE ON/OFF button on the remote control.
4. Press the Start/Stop button to start recording the title.
5. Press the TITLE ON/OFF button on the remote control to stop recording the title. The title graphics disappear from the viewfinder and the camcorder can record normally.

Note: Create and store your title before an event you plan to record. Just press the TITLE ON/OFF button on the remote control to superimpose the title over the scene as you record it. This method avoids erasing previously recorded material which will happen when you record a title on a previously recorded tape.

Note: Title recording is disabled when you connect the optional AV input cable to the AV IN/OUT jack to record video and audio from the television or VCR.

Recording a Created Title while Transferring a Tape

1. Connect the camcorder to the VCR (p.26).
2. Turn on the VCR and set it to record. Hold down the red button on the CAM/OFF/VIDEO switch while sliding the switch to VIDEO. Press PLAY on the camcorder.
3. Press the TITLE ON/OFF button on the remote control at the point on the tape where you wish to record the title.
4. Press the TITLE ON/OFF button on the remote control again to stop recording the title.

Note: Recording the title during tape transfer will erase a portion of your recorded material.

Using Audio/Video Dubbing

Use audio/video dubbing to record audio and video from the camcorder's built-in microphone and camera onto a previously recorded tape in the camcorder.

Remote Control Audio/Video Dubbing Buttons

1. Connect your camcorder to the television, following "Connecting to a Television with Audio In and Video In Jacks" on page 27.
2. Turn on your television and place it in the camcorder input mode (consult your television manual for details).
3. Hold down the red button on the CAM/OFF/VIDEO switch while sliding the switch to VIDEO.
4. Insert a previously recorded tape in the camcorder.
5. Use the wireless remote control and press the PLAY button. Use the PLAY, F.FWD, and REW buttons to find the place where you want to stop dubbing. Press the PAUSE (START/STOP) button.
6. Display the linear timer counter with memory ("Using Memory," p.42). Press the COUNTER RESET button to set the linear time counter to 0:00:00M.
7. Use the REW and PLAY buttons to find where you wish to start dubbing. Press the PAUSE (START/STOP) button.
8. Press and hold the A/V DUB button while pressing the PLAY button. This places the camcorder in A/V DUB pause mode.
9. Press the PAUSE (START/STOP) button. The audio/video dubbing starts. When the linear time counter reaches 0:00:00M the camcorder stops automatically, recording only the portion of the tape that you selected.

Note: If the camcorder is in AV DUB pause or STILL mode for more than 5 minutes, the camcorder stops automatically to protect the tape.

Note: Automatic date recording is disabled during audio/video dubbing.

Note: When the audio/video dubbed portion is played back, noise may appear at the end of the dubbed portion.

Using Synchro Edit

Use synchro edit to record segments of a previously recorded tape when dubbing from the camcorder to a VCR. This requires an optional synchro edit cable. The Hitachi VM-E220A uses a flying erase head to eliminate glitches or rainbow noise that sometimes occurs between edits. Your VCR must have the EDIT IN jack to use the synchro edit.

Synchro Edit Hookup Illustration

1. Connect the synchro edit cable to the AV IN/OUT jack of your camcorder.
2. Connect the synchro edit cable to the AUDIO IN, VIDEO IN, and EDIT IN jacks of your VCR. Connect either the right or left audio plug into your VCR if it has only one AUDIO IN jack.

Turn on your VCR and place it in the camcorder input mode (consult your VCR manual for details).

3. Insert the recorded tape in the camcorder and a blank tape into the VCR.
4. Play the tape in the camcorder until you find the place you want to record. Press the Start/Stop button.
5. Press the Record button on the VCR. It automatically sets to pause. If the VCR begins to record instead of pausing you need to change the position of the polarity switch on the synchro edit cable. Stop the VCR, change the position of the switch, and press the Record button on the VCR.

6. Press the S.EDIT button on the remote control and the last few seconds of the recorded tape reviews in the viewfinder and then the camcorder is placed in playback. The recording VCR starts recording automatically.

7. Press the F.FWD, REW, STOP, and Start/Stop buttons to pause the VCR. You can then search forward or back through the tape without affecting the tape in the VCR.

Use the F.FWD and REW buttons to search the tape. Press the PLAY button to resume normal playback. To resume recording on the tape in the VCR, press the Start/Stop button and then the S.EDIT button.

To fast forward or rewind the tape, press the STOP button, then F.FWD or REW. To return to recording on the tape in the VCR, press the STOP button, then the PLAY button, then the Start/Stop button, and then the S.EDIT button.

8. To stop recording at a certain point turn on the camcorder's linear time counter with memory ("Using Memory," p.42). Press the COUNTER RESET button on the remote control where you wish the recording to stop. The linear time counter resets to 0:00:00M. Rewind to the point where you wish to start recording and start copying. When the linear time counter reaches 0:00:00 the recording stops automatically, pausing the VCR in the record mode.

Note: If the tape counter reads "0:00:00M" you cannot start recording.

Simple Programmable Edit (Edit remote control is optional accessory)

Simple programmable edit allows you to program your camcorder to select the scenes you want to copy from a pre-recorded tape. Use the edit remote control (optional) to easily copy scenes from a recorded tape in the camcorder (playback machine) onto a blank tape in a table-top VCR which handles infrared signals (recording machine).

Note: Only the VM-RM20EDA edit remote control (optional) can be used with this camcorder.

Note: Some VCRs cannot be operated by the edit remote control (optional).

Example of Programmable Editing

Programming the Remote Control for the VCR

It is necessary to program the edit remote control to match the VCR before starting editing.

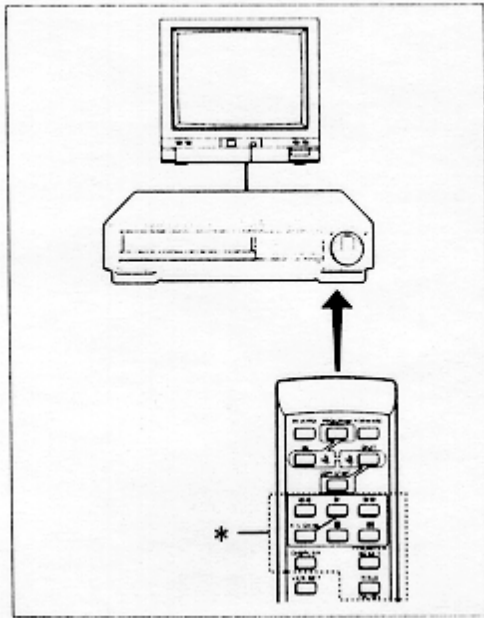

1. Turn the VCR on.
2. Aim the remote control at the infrared receiver on the VCR and press the VCR SET button on the remote control and hold it, then press the button corresponding to the VCR's maker code. For example, if you have a RCA VCR, press the VCR SET button and hold it, then press the DISPLAY button. To check whether the remote control code matches that of your VCR or not, point the remote control at the infrared receiver on the VCR and press the VCR SET button and hold it. If the remote control code has been set, the VCR channel is counted up automatically.

Note: Your VCR should have an infrared remote control.

Note: If the channel on the VCR does not change with the above operation, you need to switch the remote control code of your VCR. Refer to the VCR's instruction manual. If the channel still does not change after you have changed the VCR's remote control code, the edit remote control cannot operate your VCR.

VCR Brands Press VCR SET and This Button

Hitachi	REVERSE
Sony	PROGRAM
Panasonic	FORWARD
Toshiba	IN
Mitsubishi	COPY START
Sanyo	OUT
Sharp	◀
NEC	▶
JVC	▶▶
Akai	A/V DUB
Gold Star	■
PHILIPS	
RCA	DISPLAY
Zenith	COUNTER RESET

Note: The remote control code is held in memory until it is changed or the batteries are replaced.

Note: Point the remote control straight at the VCR's infrared receiver for operation.

Note: Use the remote control indoors. When the infrared receivers of the VCR and camcorder are exposed to direct sunlight or strong artificial light, the remote control may not operate correctly.

Note: The remote control cannot be operated if there is an obstacle between the remote control and infrared receiver. Especially, be careful of this during dubbing.

Note: When the edit remote control is connected to the camcorder, the buttons marked * in the figure above perform the same operations as those of the other remote control provided.

Operation

You can select up to four different scenes or segments to be copied at one time.

Note: If sunlight or strong artificial light strikes the camcorder's infrared receiver, the editing operation may not be possible.

Programmable Edit Hookup

1. Use the audio/video output cable to connect the camcorder and VCR as illustrated and then connect the edit remote control to the camcorder.

Note: If your VCR has two (stereo) AUDIO IN jacks, connect the audio plug to the left-channel AUDIO IN jack.

2. Insert a recorded tape into the camcorder.

3. Set the CAM/OFF/VIDEO switch of the camcorder to VIDEO. Turn the recording VCR on and select line input.

4. Press the PROGRAM button of the remote control. The program display appears in the viewfinder.

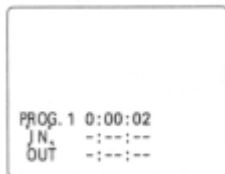

Note: If your VCR is connected to a TV, the program display will also appear on the TV screen.

5. Press the **▶** button and use the **▶▶** or **◀◀** button to search for the starting point of the segment you want to copy. Press **▶** and then **⏸** to set the camcorder to the play pause mode.

The linear time counter counts when searching for the starting point.

Use the FORWARD and REVERSE buttons in the play or pause mode to fine adjust the tape position. Press FORWARD and hold it; the tape is played while the button is held. Press REVERSE and hold it for reverse play.

6. Press the IN button to store the counter reading. When you press the IN button, OUT flashes in the program display.

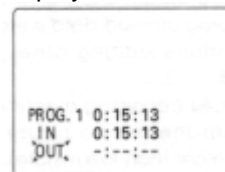

7. Press the **▶▶** button to search for the end of the segment you want to copy. Press **▶** and then **⏸** to set the camcorder to the play pause mode. Use the FORWARD or REVERSE button as required to fine adjust the tape position.

8. Press the OUT button to store the counter reading at the end of the scene.

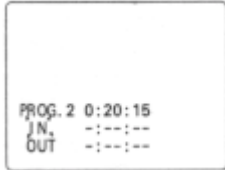

9. Continue programming as described above until you have entered up to four different segments.
10. Load a blank tape, then set the VCR to the record pause mode.
11. Point the remote control at the receiver on the VCR and press the COPY START button to start simple programmable edit.
 - The camcorder automatically searches for the beginning of the first segment and starts playback. The recording VCR automatically starts recording
 - After recording the first segment, the camcorder automatically searches for the beginning of the next segment and resumes playback. The recording VCR is automatically released from the record pause mode and resumes recording.
 - It continues recording and pausing until all the programmed segments are edited.
12. When simple programmable edit is finished, the camcorder will enter the stop mode, and the VCR will enter the record pause mode.

Note: If you make a mistake during programming, start again from the beginning or press the COUNTER RESET button to return to the previous steps one by one and enter the correct program data.

Note: After the simple programmable edit is finished, the programmed data is erased. If you want to continue editing other segments, repeat steps 5 - 12.

Note: Most VCRs (recording machine) may be released from the record pause mode if it continues for more than five minutes.

Note: The dubbing start and end positions may slightly drift from the specified positions when certain VCRs are used.

To End Programmable Simple Edit

Press the PROGRAM button to remove the program display from the viewfinder. Then press the stop button on the recording VCR to set it to the stop mode.

Note: If the CAM/OFF/VIDEO switch of the camcorder is set to OFF or CAM when the recording VCR is in the record pause mode, the VCR enters the record mode.

Attaching the Optional Wide or Tele Converter Lens

1. To remove the lens hood, turn it counterclockwise.

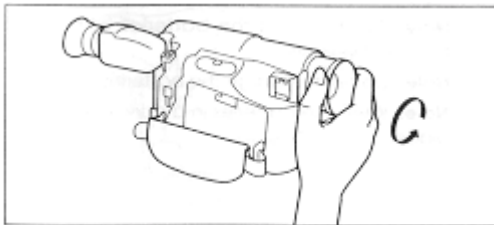

2. Remove both caps of the converter lens.
3. Screw the lens into the threads on the camcorder lens assembly.

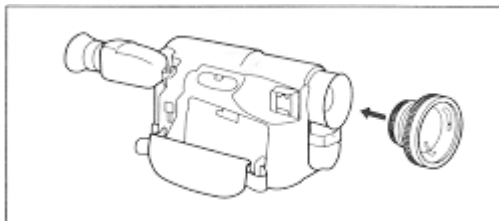

Attaching the Optional DC Camera Light

You can use the DC camera light to light subjects in darkened areas or correct unflattering shadows. Use the camera light wisely as it greatly reduces the time you may use a charged battery.

NEVER TOUCH THE DC CAMERA
LIGHT TERMINAL WHEN
THE CAMCORDER IS TURNED ON TO
AVOID ELECTRIC SHOCK.

1. Slide the CAM/OFF/VIDEO switch to OFF.
2. Connect a fully charged batteries or the AC adapter/charger ("Loading Batteries; Camcorder Batteries" p.15, "Using Alternative Power Sources" p.17).
3. Slide the DC camera light onto the DC camera light shoe with the camera light lens facing the same direction as the camcorder's lens.
4. Hold down the red button on the CAM/OFF/VIDEO switch while sliding it to CAM.
5. Press the operate button on the DC camera light to turn it on and off.

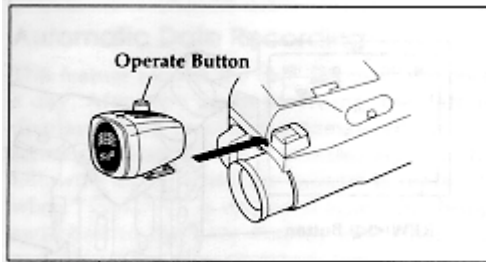
**Notes when using the DC camera light:**

- Keep the DC camera light away from splashing or dripping water.
- Never cover the DC camera light with paper, plastic or other object as the cooling vents may become blocked possibly causing the camera light to overheat.
- Never use the DC camera light in the vicinity of explosive or highly flammable materials.
- Always allow the DC camera light to cool fully before storing.
- The DC camera light becomes very hot during use of the camera light or immediately after use. Be careful that your hand or hair does not touch them.
- When the DC camera light is on, avoid subjecting the camera light to impacts or sharp vibrations.
- If the DC camera light is turned on and off during recording, there could be noise in the picture. Watch the battery charge indicator especially when using a battery as the power source.
- When the DC camera light is used, the operation time of the camcorder when a fully-charged battery pack is attached is halved.

Removing the DC Camera Light

Depress the light to release the tab from the hook and then move the light in the direction of the arrow as shown in the figure.

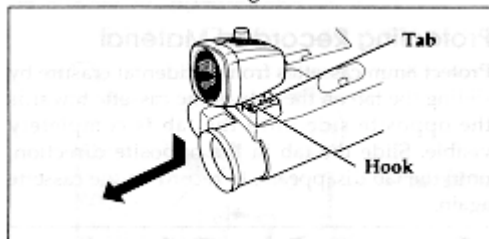
**Replacing the DC Camera Light Bulb**

1. Turn the front of the case counter-clockwise and remove it.



2. Remove the bulb by pulling it out through the opened case.

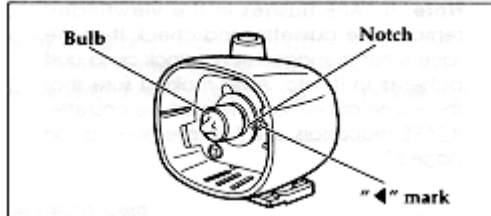

3. Install the new bulb by aligning the notch in the rim of the bulb's base with the "<" mark outside the socket. Avoid touching the bulb directly with your fingers. It may shorten the life of the bulb.

4. Reattach the front of the case by placing the bulb in the hole of the reflective plate, lining up the smaller "-" mark on the front of the cover with the "-" mark on the DC camera light, and turning the front of the cover clockwise till the larger "-" mark on the front of the cover aligns with the "-" mark on the DC camera light. Check that the front of the camera light is attached properly before turning the light on.

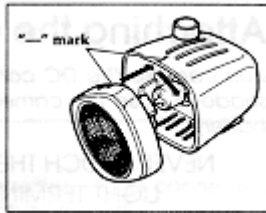

Note: Only replace the camera light bulb with VM-CP4L (optional) to reduce the risk of fire.

Viewfinder Bright, Color and Tint Control

This small "BRIGHT", "COLOR" and "TINT" controls are set at the factory and should require no adjustment. If they ever require adjustment, use a plastic screwdriver. Make the adjustments with caution to prevent damaging the miniature controls.

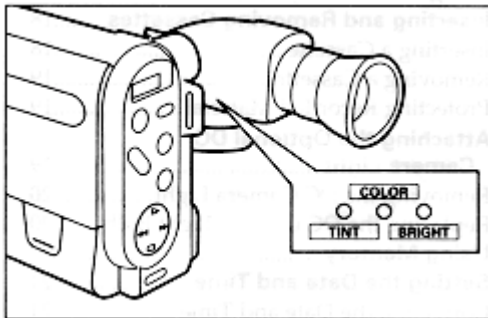

General Maintenance

Cleaning the camcorder Heads

Dirt can accumulate on the video heads on the camera causing the playback picture to become blurred or appear as if video information is lost. This often means that the video heads are dirty. Use a video head cleaner such as a dry type head cleaning tape to clean the heads.

If after cleaning the heads the picture does not clear up consult your nearest dealer or VCR service center for professional head cleaning.

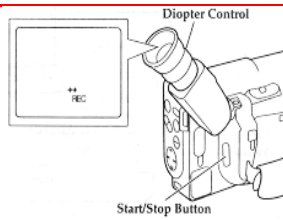

Cleaning the Lens and Picture Tube of the Electronic Viewfinder

The lens of the electronic viewfinder can be user-cleaned if dust, dirt, or other foreign matter adheres to it.

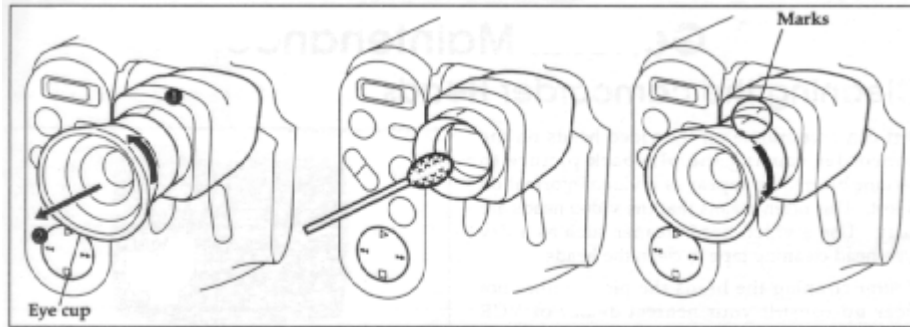

1. Rotate and remove eye cup.
2. Clean the picture tube face and lens.
To prevent scratching, use a soft non abrasive cloth, swab or lens cleaning paper.
3. Fit the projection of the eye cup into the groove in the viewfinder and rotate the eye cup in the direction of the arrow.

Periodic Maintenance

A precision electromechanical device, the Hitachi VM-E220A requires maintenance after a period of normal use. We expect that no other maintenance other than head cleaning will be required during the period of warranty unless the camcorder is used either heavily or seldom. Defective parts are covered by the warranty. Normal maintenance is the responsibility of the owner. Consult your dealer or local VCR service center for recommendations regarding normal maintenance based on your use patterns, location, and the age of the camcorder.

Troubleshooting

Quality is very important at Hitachi. We inspect and check every camcorder carefully at the factory under the most rigid quality control and inspection systems. If problems develop please check the following possible solutions before inquiring about professional service.

INSERTING OR REMOVING THE CASSETTE

Symptom

Cassette holder cannot be opened when you slide EJECT switch

Check Point & Correction

Connect the power source

Cassette cannot be inserted into cassette compartment

Load cassette in direction indicated by arrow on cassette. Cassette window must be toward outside.

CAMERA RECORDING

Symptom

Check Point & Correction

Picture does not appear in the viewfinder.

- Remove the lens cap.
- Slide the CAM/OFF/VIDEO switch to CAM
- Disconnect the AV input cable from the camcorder

The camcorder cannot go into the recording

Check the record-protect tab on the cassette mode, even when the start/stop button is pressed See page 19 for details

Picture is out of focus.

- Push the cassette holder embossed PUSH LOCK to close it.
- Slide the CAM/OFF/VIDEO switch to CAM • Make sure that FOCUS does not appear in the viewfinder. If it is displayed, press FOCUS Control buttons to erase it

Auto-focus does not operate.

- Auto-Focus does not operate if a special-effects filter is attached or the objects shown on page34 are being recorded.

The created title does not appear. after creating a title.

- Insert the clock battery, then create a title.
- Do not remove the clock battery

RECORDING TV PROGRAMS OFF THE AIR

Symptom

The camcorder cannot be set to the recording

Check Point & Correction

- Check the record-protect tab on the cassette mode, even when the Start/Stop button on the camcorder is pressed. See page 19 for details
- Set the CAM/OFF/VIDEO switch to CAM.
- Connect the camcorder and TV or VCR.

PLAYBACK OF PRE-RECORDED CASSETTE

Symptom

"PLAY" button cannot be engaged.

Check Point & Correction

- Set the CAM/OFF/VIDEO switch to VIDEO.

No picture appears on television screen when "PLAY" is pressed. (TV is connected to the camcorder by using RF output adapter.)

- Set the television to the camcorder channel (3 or 4) depending upon the selected channel in the RF channel select switch of RF output adapter.

Interference on playback picture. (TV is connected to the camcorder by using RF output adapter.)

- When you see the playback picture on your TV adjust fine tuning knob on television set to obtain best picture.
- Color of your TV screen is too bright, too faint or
- TV set has VIR circuit. Turn it off during playback.
- TV receiver is of older type. It needs to be modified to work properly with camcorder.
- Tape is damaged. Try another cassette.

Picture bends at the top of the TV screen.

- TV receiver is of older type. It needs to be modified to work properly with camcorder.

Date search function does not operate

- Slide the CAM/OFF VIDEO switch to VIDEO.
- Insert the clock battery, set the date and time, then start recording.
- Do not remove the clock battery after recording.

The playback picture moves rapidly and noise appears. Also sound speeded up from normal is heard.

- Do not eject the recorded cassette. Leave it in the camcorder.
- The camcorder is set to the double speed playback mode. Pressing the playback button to restore the normal playback mode. The sound also returns to the normal speed Noise appears in the picture during double speed playback, but this does not indicate a fault. See page 30 for details.

BATTERY CONDITION

Symptom

The () indication in the electronic viewfinder flashes to indicate battery is discharged.

Check Point & Correction

- Try another battery or charge the battery.

NO OPERATION IS ACCEPTED

Symptom

Check Point & Correction

Power is turned on, but no button operations are accepted

- Remove the power source and the date/title battery. And, after about one minute, the display in the viewfinder will be reset. Then set the information again.

The camcorder does not operate when alkaline batteries are inserted

- Check that the polarities (+, -) of the batteries are correct. Insert six batteries.

TAPE DISPLAY

Symptom

TAPE appears in the viewfinder.

Check Point & Correction

- Have you moved the camcorder or cassette from a cold place to a warm place so that its temperature changed abruptly? If the temperature has changed, remove the cassette and set the CAM/OFF/VIDEO switch to OFF, then wait for about one hour. Remove the cassette and then try to reinsert: remove it several times. If the indication is still shown in the viewfinder, use a cleaning tape to clean the heads and replace the cassette.

Specifications

General Specifications

Power requirements	6V DC
Power consumption	5.3W (when recording)
Dimensions	3-11/16" W x 4-3/4" H x 8-5/16" D (94mm x 120mm x 211mm)
Weight	1.87 lbs (approx. 850g) without battery pack, lens hood, lens cap or cassette
Operating temperature	32°F ~ 104°F (0°C ~ 40°C)
Storage temperature	-4°F ~ 140°F (-20°C ~ 60°C)

Video Recorder Specifications

Format	8mm
Record/playback	Two video record/playback heads
Video signal	EIA standard NTSC color
Tape speed	14.3mm/sec
Video input	1.0Vp-p, 75 ohm
Video output	1.0Vp-p, 75 ohm
Audio input	-7.8dBs (316mVrms)
Audio output	-7.8dBs (316mVrms)
Fast forward/rewind time	Less than 8 minutes with P6-120 cassette

Camera Specifications

Scanning	525 lines/60 fields/30 frames
Required minimum illumination	1 lux
Pickup device	1/4" C.C.D.
Lens diameter	46mm

For U.S.A. only

HITACHI

Service Hotline
To locate an authorized
HITACHI service facility
in the continental U.S.A.

DIAL TOLL FREE

7 days a week, 24 hours a day
800 HITACHI
1-800-448-2244

Hitachi Home Electronics (America), Inc.

Hitachi has made every effort to assure you hours of trouble free operation from your unit. However, should you require service, a network of Hitachi Authorized Service Facilities has been established in all 50 states and Puerto Rico. Each facility will provide you with convenient and expedient assistance. Our service "Hotline" operator will direct you to the Hitachi Authorized Service Facility nearest you. Just present proof of purchase and/or delivery receipts to the Hitachi Authorized Service Facility and service will be rendered in accordance with the terms of the limited warranty as stated on your warranty card or operating guide.

Should you have any questions regarding in-warranty service, operation or technical assistance, please contact:

Hitachi Home Electronics (America), Inc.

3890 Steve Reynolds Blvd
Norcross, GA 30093
Tel 404-279-5600

Hitachi Sales Corporation of Hawaii

3219 Koapaka St./Honolulu, HI 96819
Tel 808-836-3621

Accessories Add Excitement

We know that once you discover how much your Hitachi VM-E220A can add to your life you will want to use these accessories for even more excitement. Converter lenses, adapters for synchro editing, and car cords are just a few of the exciting accessories available to you from Hitachi. Hitachi takes you to wherever your imagination leads.

Available Accessories

Click to see Available Accessories

To place an order for any of these items call our toll free number or use the ordering form on page 61.

1-800-995-4500

More Available Accessories

Click to see More Available Accessories

To Order in the United States

In Canada - Please use Canadian order form in French version of this manual - Page 61.

By Phone

To place an order by phone, have your VISA, MASTERCARD, or DISCOVER card ready and call the toll-free number (8:00AM ~ 6:00PM East Coast Time - workdays).

1-800-995-4500

By Mail

Complete the order form on page 67. Detach it and send it to the following address with your credit card information, money order, or check (in U.S. currency and payable to HiTRON, Inc.). HiTRON is a subsidiary of Hitachi Home Electronics (America), Inc.

**HiTRON, Inc.
675, Old Peachtree RD.
Suwanee, GA 30174**

Please allow two to three weeks for delivery. If there is a current back order status on the model(s) you ordered, we will notify you.

Thank you for allowing us (Hitachi and HiTRON) to be of service to you...our valued customer!

Order form

VM-E520A/VM-E521A

iIntroduced in 96-97 product line. Mention as "current" product.

Warranty: 1 year parts, 90 days labor

iiNo, this camera does not have fading as a feature.