

# Instruction Manual

**ETX-60AT Astro Telescope with Autostar Hand Controller**  
**ETX-70AT Astro Telescope with Autostar Hand Controller**



**Meade Instruments Corporation**



## WARNING!

**Never use a Meade® ETX® Astro Telescope to look at the Sun!** Looking at or near the Sun will cause instant and irreversible damage to your eye. Eye damage is often painless, so there is no warning to the observer that damage has occurred until it is too late. Do not point the telescope or its viewfinder at or near the Sun. Do not look through the telescope or its viewfinder as it is moving. Children should always have adult supervision while observing.

**CAUTION:** Use care to install batteries in the orientation indicated by illustration in the battery slots of the battery holder. Follow battery manufacturer's precautions. Do not install batteries backwards or mix new and used batteries. Do not mix battery types. If these precautions are not followed, batteries may explode, catch fire, or leak. Improperly installed batteries void your Meade warranty.

**If you are anxious to use your telescope for the first time,** read the QUICK-START GUIDE on page 3.

© The name "Meade," the Meade logo, and "ETX" are trademarks registered with the U.S. Patent Office and in principal countries throughout the world. All rights reserved.

Design: Automated Telescope - Patent No. D417881

© 2000 Meade Instruments Corporation.

# CONTENTS

Quick-Start Guide .....	3
Telescope Features .....	4
Autostar Features .....	7
Getting Started .....	10
Parts Listing .....	10
How to Assemble Your Telescope .....	10
Choosing an Eyepiece .....	10
Manual Operation Without Using Autostar.....	11
Manual Operation Using Autostar's Arrow Keys .....	11
Moving Through Autostar's Menus .....	12
Initializing Autostar .....	12
Autostar Operation .....	13
Autostar Navigation Exercise .....	13
Easy Two-Star Alignment .....	14
Observing Exercises .....	15
Go To Saturn .....	15
Using the Guided Tour .....	15
Autostar Menus .....	16
Complete Autostar Menu Structure .....	16
Objects Menu .....	16
Event Menu .....	17
Glossary Menu .....	18
Utilities Menu .....	18
Setup Menu .....	19
Advanced Features .....	21
Terrestrial and Astronomical Observing .....	21
Sidereal Rate .....	21
Alignment (Mount) .....	21
Alt/Az Alignment .....	21
Alt/Az Home Position .....	21
Two-Star Alt/Az Alignment.....	21
One-Star Alt/Az Alignment .....	21
Slew Speeds.....	22
Observing a Satellite .....	23
Photography with the ETX .....	23
Optional Accessories .....	25
Maintenance and Servicing .....	27
Storage and Transport .....	27
Inspecting the Optics .....	27
Troubleshooting .....	28
Meade Customer Service .....	29
Specifications .....	29
Appendix A: Equatorial (Polar) Alignment .....	31
Appendix B: Using Autostar to Enter Coordinates .....	33
Appendix C: Helpful Charts .....	34
Appendix D: Training the Drive .....	35
Appendix E: Initialization Example .....	36
Basic Astronomy .....	37
Roadmap to the Stars .....	39

# QUICK-START GUIDE

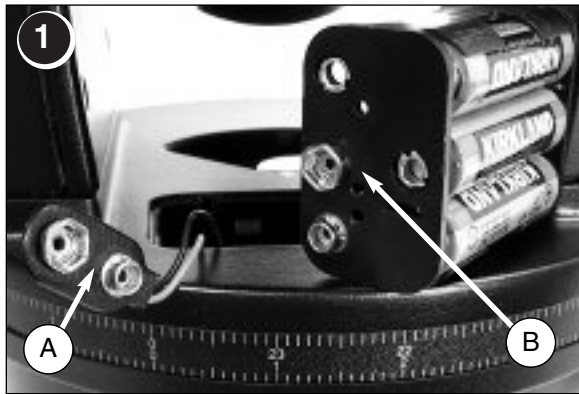

1. Take the ETX from its packaging and place it on a sturdy surface. Remove the cover from the battery compartment (20, Fig. 1, page 4) located on top of the drive base and carefully lift the 9v connector and the battery holder from the compartment. Insert six AA-size batteries into the battery holder, oriented as shown on the battery holder. Connect the 9v connector plug (A) to the connector (B) on the battery holder. Return the battery holder to the battery compartment. Replace the cover. See page 10 for more information.

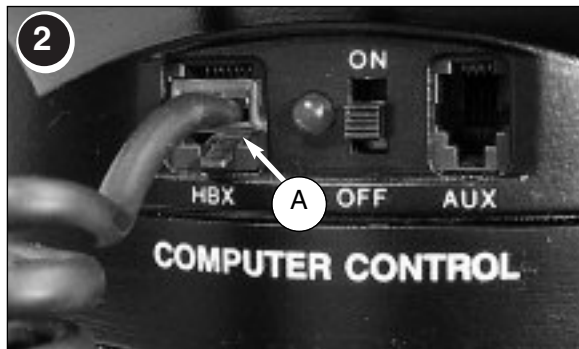

2. Make sure that the computer control panel power switch is in the OFF position. Remove Autostar (18, Fig. 1) from the packing materials and plug it into the HBX port (A).

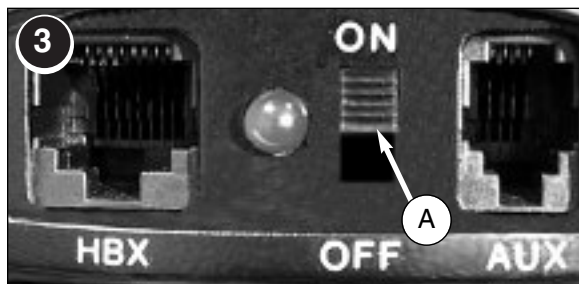

3. Flip the Power Switch (A) on the computer control panel to the ON position. The copyright message lights on Autostar's LCD display.

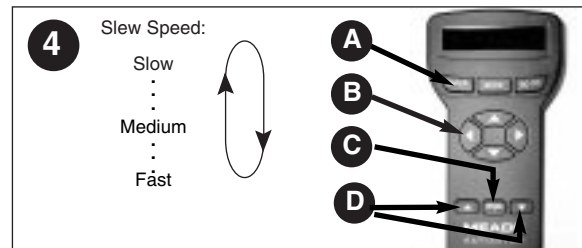

4. Press the Speed/? key (C) to accept the Sun warning. Keep pressing the ENTER key (A) until "Country/State" appears on the display. (Ignore the prompts requesting "Date" and "Time" for now – these functions will be explained later). Use the Scroll keys (D) to cycle through the lists of Country/States, Cities, and Telescope Models. Press ENTER (A) when the correct information for each prompt displays. The display then reads "Setup: Align." See page 11 for more information.

You can now use the Arrow keys (B) to slew (move) the telescope up, down, right, or left. To change the telescope's slew speed, briefly press the Speed/? key (C). Each press decreases the slew speed down one level, and then will cycle back to the fastest speed.

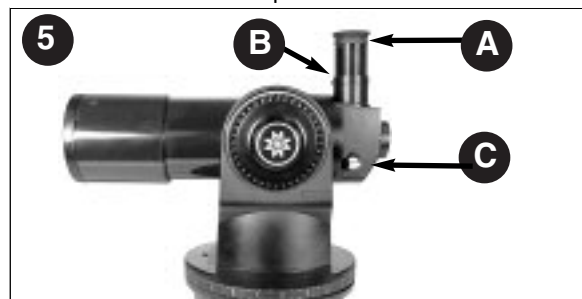

5. Tighten (to a "firm feel" only, do not overtighten) the vertical and horizontal locks (6, 9, Fig. 1). See page 5 for more information. Remove the dust cover from the end of the telescope tube. Place the MA 25mm eyepiece (A) into the eyepiece holder on the telescope and tighten the attachment thumb-screw (B) to a "firm feel" only. Make sure that the flip-mirror control (C) is in the "up" position. See page 6, for more information.



6. Sight along the side of the telescope's main tube to locate an object. Practice using the Autostar's Arrow keys to center an object in the telescope's field of view. Use the telescope's focus knob (8, Fig. 1) to bring the object into focus.

### If you wish to observe using Autostar's databases, go to:

Page 14 to learn how to perform an Easy Two-Star Alignment;  
 Page 15 for some practice observing exercises;  
 Page 16 to learn about Autostar's menus and databases.

# TELESCOPE FEATURES

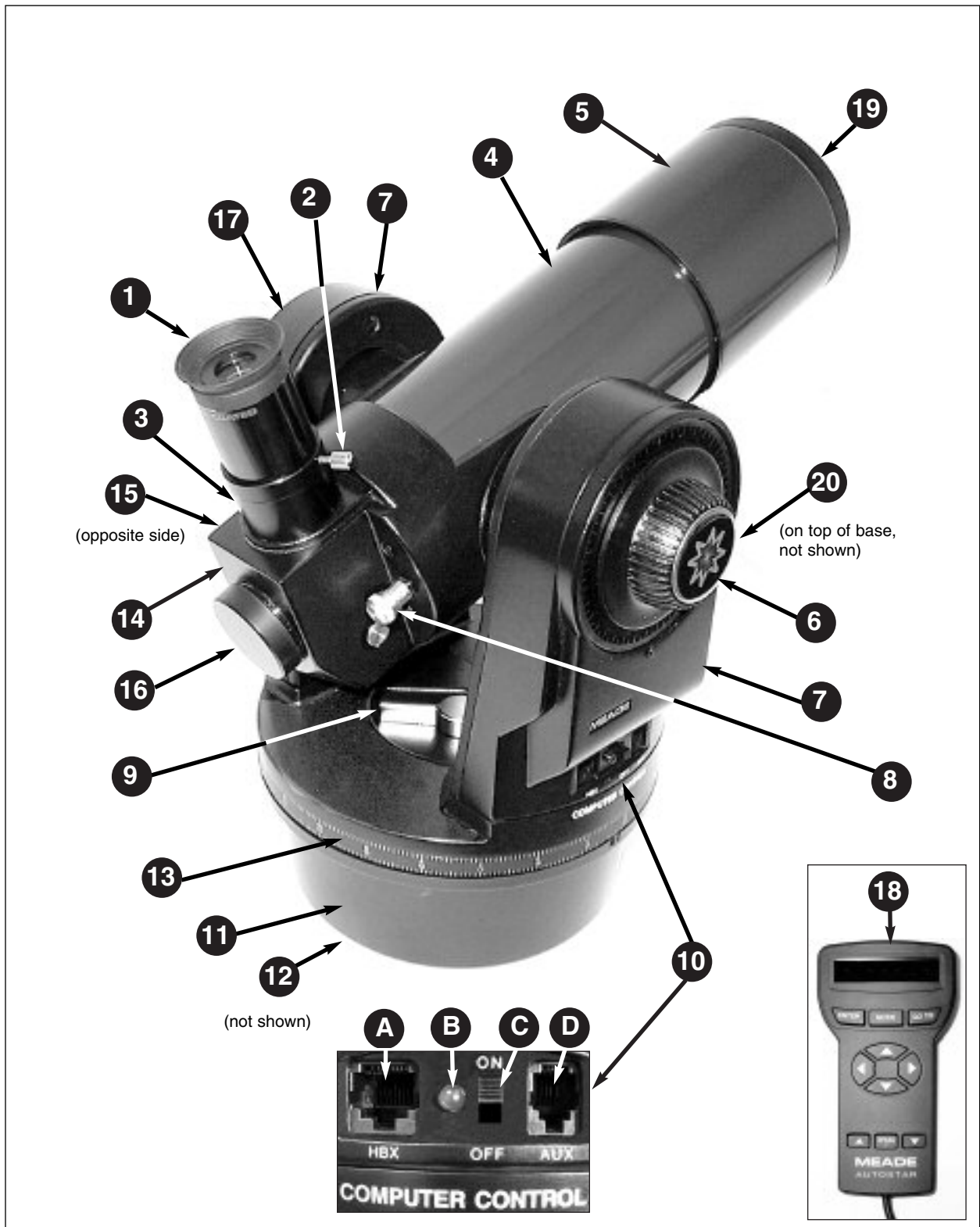

Fig. 1: The ETX-60AT and ETX-70AT Telescope.

Except for the lens diameter, the Meade ETX-60AT and the ETX-70AT are identical; all procedures and descriptions in this manual apply to both telescopes.

**CAUTION:**

Using products other than standard Meade accessories may cause damage to the telescope's internal electronics and may void the Meade warranty.

## ETX: Your Personal Window to the Universe

The Meade ETX-60AT and the ETX-70AT are extremely versatile, high-resolution telescopes with features similar to those once available only with larger and more specialized imaging systems. With pushbutton controls, automatic tracking of celestial objects, and software downloading capability, an ETX telescope may be all the telescope ever required by many terrestrial and astronomical observers.

Your ETX telescope reveals nature in an ever-expanding level of detail. Observe the feather structure of an eagle from 50 yards or study the rings of the planet Saturn from a distance of 800 million miles. Focus beyond the Solar System and observe majestic nebulae, ancient star clusters, remote galaxies, and even stars recently discovered to have planets orbiting about them. Meade ETX telescopes are instruments fully capable of growing with your interest and are ideal for both the casual observer and serious astronomer alike.

- 1  **Eyepiece**  - Place the MA 25mm eyepiece into the 90° Eyepiece Holder (3, Fig. 1) and tighten in place with thumbscrew (2, Fig.1).
- 2  **Eyepiece Holder Thumbscrew**  - Tightens the eyepiece in place. Tighten to a "firm feel" only.
- 3  **90° Eyepiece Holder**  - Holds the eyepiece upright for easy viewing.
- 4  **Optical Tube**  - The main optical component that gathers the light from distant objects and brings this light to a focus for examination with the eyepiece.
- 5  **Movable Objective Lens Cell**  - This component contains the telescope's lenses. The focus knob (8, Fig. 1) moves the cell for precise image focus.
- 6  **Vertical Lock**  - Controls the manual vertical movement of the telescope. Turning the vertical lock counterclockwise unlocks the telescope enabling it to be freely rotated by hand about the vertical axis. Turning the vertical lock clockwise (to a "firm feel" only) prevents the telescope from being moved manually, but engages the vertical motor drive for Autostar operation.

***NOTE:** The vertical lock knob (6, Fig. 1) is a knurled knob located on the fork arm to the right of the focus knob (8, Fig. 1). Mounted beneath the knob is a circular scale with no numbers. Do not confuse this scale with the Dec setting circle (17, Fig. 1) on the opposite fork arm which has a numbered scale used to locate astronomical objects.*

***CAUTION:** When loosening the vertical lock, be sure to support the objective lens cell (5, Fig. 1). The weight of the objective lens could cause the tube to swing downward suddenly and damage the telescope.*

- 7  **Fork Arms**  - Hold the optical tube in place.
- 8  **Focus Knob**  - Moves the telescope's objective lens (5, Fig. 1) in a finely-controlled motion to achieve precise image focus. The ETX-60AT and ETX-70AT telescopes can be focused on objects from a distance of about 17 ft. to infinity. Rotate the focus knob clockwise to focus on distant objects, and counterclockwise to focus on nearby objects.
- 9  **Horizontal Lock**  - Controls the manual horizontal rotation of the telescope. Turning the horizontal lock counterclockwise unlocks the telescope, enabling it to be freely rotated by hand about the horizontal axis. Turning the horizontal lock clockwise prevents the telescope from being rotated manually, but engages the horizontal motor drive for Autostar operation.

## 10 Computer Control Panel

- A. **Handbox (HBX) Port** - Plug the Autostar coil cord (9, Fig. 3) into this port.
- B. **LED** - The red power indicator light illuminates when power is supplied to the Autostar handbox and to the telescope's motor drive.
- C. **ON/OFF Switch** - Turns the Computer Control Panel and Autostar ON or OFF.
- D. **Auxiliary (AUX) Port** - Provides connection for current and future Meade accessories, such as the Meade "AstroFinder Software with Cable Connector Kit," which allows you to control your ETX from a PC. See "OPTIONAL ACCESSORIES," page 25.



**Fig. 2a:** Flip mirror control in the "up" position.



**Fig. 2b:** Flip mirror control in the "down" position.

- 11 **Base Housing** - Supports the telescope for placement on a flat, level surface, such as a tabletop or optional tripod. See "OPTIONAL ACCESSORIES," page 25.
- 12 **Holes for Optional Tripod** (not shown, on the bottom plate) - See your tripod's instruction sheet for mounting information.
- 13 **Right Ascension (R.A.) Setting Circle** - See "APPENDIX A," page 31, for detailed information.
- 14 15 **Cellback containing Flip-Mirror and Flip-Mirror Control Knob** - ETX telescopes include an internal mirror. With the flip-mirror control in the "up" position, as shown in Fig. 2a, light is diverted to the eyepiece. With the flip-mirror control in the "down" position, as shown in Fig. 2b, light proceeds straight out the photo port for photography. See "PHOTOGRAPHY WITH THE ETX," page 23.  

*NOTE: The flip-mirror control is in the "up" position when the control is vertical (perpendicular to the telescope tube). To place the flip-mirror in the "down" position, turn the control counterclockwise until it stops.*
- 16 **Photo Port** - Attach any 35mm camera with a removable lens to this port using an optional #64ST T-Adapter or attach the #933 Erecting Prism for correctly oriented images through the eyepiece. See "OPTIONAL ACCESSORIES," page 25.
- 17 **Declination (Dec) Setting Circle** (on left fork arm) - See "APPENDIX A," page 31, for detailed information.
- 18 **Autostar with attached coil cord** - See page 7 for a description of Autostar's features.
- 19 **Dust Cap** - Unthread the dust cap counterclockwise from the front lens of the telescope.  

*NOTE: The dust cap should be replaced after each observing session and the power turned off to the telescope. Verify that any dew that might have collected during the observing session has evaporated prior to replacing the dust cap.*
- 20 **Battery Compartment** - Install batteries in this compartment. See page 10 for more information.

# AUTOSTAR FEATURES



Fig. 3: #494 Autostar Handbox.

## Tour the Cosmos with Just the Push of a Button

Control of the ETX-60AT and the ETX-70AT is through the operation of the standard-equipment #494 Autostar. Nearly all functions of the telescope are accomplished with just a few pushes of Autostar's buttons. Some of the major features of Autostar are:

- Automatically move the telescope to any of the 1400 objects stored in the database or manually enter the astronomical coordinates of any celestial object.
- Take a guided tour of the best celestial objects to view on any given night of the year.
- Download the latest satellite data and software revisions directly from the Meade website ([www.meade.com](http://www.meade.com)) and share software with other Autostar enthusiasts. (Requires optional #506 AstroFinder™ Software and Cable Connector Kit. See "OPTIONAL ACCESSORIES," page 25.)
- Access a glossary of astronomical terms.
- Calculate which eyepiece to use for optimum viewing of a celestial object.
- Mount the telescope in the "Alt/Az" mode (Altitude - Azimuth, or vertical - horizontal) for fully automatic tracking of celestial objects using a flat, level surface, such as a tabletop, or the optional #882 Standard Field Tripod. (See "OPTIONAL ACCESSORIES," page 25.)

The Autostar Computer Controller provides control of virtually every telescope function within a compact handbox. Autostar has soft-touch keys designed to have a positive feel. The LCD (Liquid Crystal Display) is backlit with a red LED (Light Emitting Diode) for easy viewing in the dark. The backlit display, key arrangement, and sequential database make Autostar extremely user friendly.

**NOTE:** *Autostar does not require batteries; the telescope's batteries supply power to Autostar.*

- 1 **2-Line LCD Display** - Provides an interface between Autostar and the telescope.
  - **Top line:** Lists the primary category or menu item.
  - **Bottom line:** Contains a menu option or information about an object or subject, depending on which function is being performed.
- 2 **ENTER Key** - Accesses, in a sequential manner, the next menu or data level in the Autostar database. See "MOVING THROUGH AUTOSTAR'S MENUS," page 12 and "AUTOSTAR'S MENUS," page 16.

**NOTE:** *If ENTER is pressed for two seconds or more and then released, Autostar emits a beep and "ENTER to Sync" is displayed. "ENTER to Sync" is relevant only after the telescope has been aligned and is pointing at an object. If the "ENTER to Sync" feature is accessed by mistake, press MODE to return to the previous screen. See "HIGH PRECISION," page 20, for more details about this feature.*

- 3 **MODE Key** - Returns to the previous menu or data level in the Autostar database until the top level, "Select Item," is reached. The MODE key is similar to the ESCAPE key on a computer.

**NOTE:** *Pressing MODE while in the "Select Item" level moves Autostar to the top-most screen: "Select Item: Object."*

**NOTE:** *If MODE is pressed and held for two seconds or more, the following information is then available using the Scroll keys (6 and 7, Fig. 3):*

- *Right Ascension and Declination (astronomical) coordinates (see "APPENDIX A")*
- *Altitude (vertical) and Azimuth (horizontal) coordinates*
- *Local Time and Local Sidereal Time (LST)*
- *Timer and Alarm Status*

*Press MODE again to return to the previous menu.*

- 4 **GO TO Key** - Slews (moves) the telescope to the coordinates of the currently selected object. While the telescope is slewing, the operation may be aborted at any time by pressing any key except GO TO. Pressing GO TO again resumes the slew to the object.
- 5 **Arrow Keys** - Slew the telescope in a specific direction (up, down, left, and right), at any one of nine different speeds. Speed selection is explained in "SLEW SPEEDS," page 22. The following functions are also available with the Arrow keys:

- **Data Entry** - Use the Up and Down Arrow keys to scroll through the letters of the alphabet and numerical digits. The Down Arrow key starts with the letter "A" and the Up Arrow key starts with the digit "9." The Left and Right Arrow keys are used to move the blinking cursor left and right across the LCD display.
- **Alt/Az Alignment** - Use the Up and Down Arrow keys to move the telescope vertically up and down. The Left Arrow key rotates the telescope horizontally counterclockwise, while the Right Arrow key rotates it clockwise.

**NOTE:**

*Throughout this manual, you will notice the term "Alt/Az." Alt/Az is frequently used to refer to altitude or horizontal and azimuth or vertical. Alt/Az is just one of many methods used by amateur astronomers to help locate stars in the night sky.*



- 6 7 **Scroll Keys** - Accesses database options within a selected menu. The menu is displayed on the first line of the screen. Options within the menu are displayed, one at a time, on the second line. Press the Scroll keys to move through the options. Press and hold a Scroll key to move quickly through the options.

The Scroll keys also scroll through the letters of the alphabet and numerical digits.

**NOTE:** The Scroll Down key and the Down Arrow key move forward through the alphabet & digits (A to Z, 0 to 9). The Scroll Up key and the Up Arrow key move backward (Z to A, 9 to 0). Common symbols are also available in the list.

- 8 **Speed/? Key** - Pressing the Speed/? key cycles through the nine slew speeds that move the telescope. Each time the Speed/? key is pressed briefly, the current slew speed is shown for about two seconds on the display. See "SLEW SPEEDS," page 22.

The Speed/? key also accesses the "Help" file. "Help" provides on-screen information on how to accomplish whatever task is currently active.

**NOTE:** Pressing the Speed/? key very briefly changes the slew speed. Holding down the Speed/? key longer (one to two seconds) accesses the Help function.

Hold down the Speed/? key and then follow the prompts on the display to access details of Autostar functions in the Help feature. The Help system is essentially an on-screen instruction manual.

If you have a question about an Autostar operation, e.g., INITIALIZATION, ALIGNMENT, etc., hold down the Speed/? key and follow the directions that scroll on the second line of the LCD screen. When a word appears in [brackets], press ENTER to access the Autostar Glossary. A definition or more detailed information is displayed. Press MODE to return to the scrolling Autostar Help display.

When satisfied with the Help provided, press MODE to return to the original screen and continue with the chosen procedure.

- 9 **Coil Cord** - Plug the Autostar coil cord into the HBX port (10A, Fig. 1) of the computer control panel of the telescope.



**TIPS FOR BEGINNERS**

**Join an Astronomy Club**  
**Attend a Star Party**

One of the fun ways to learn about astronomy is to join an astronomy club. Check your local newspaper, school, library, or telescope dealer/store to find out if there's a club in your area.

At club meetings, you will meet other astronomy enthusiasts with whom you will be able to share your discoveries. Clubs are an excellent way to learn more about observing the sky, to find out where the best observing sites are, and to compare notes about telescopes, eyepieces, filters, tripods, and so forth.

Often, club members are excellent astrophotographers. Not only will you be able to see examples of their art, but you may even be able to pick up some "tricks of the trade" to try out on your ETX telescope. See page 23 for more information about photography with the ETX.

Many groups also hold regularly scheduled Star Parties at which you can check out and observe with many different telescopes and other pieces of astronomical equipment. Magazines such as *Sky & Telescope* and *Astronomy* print schedules for many popular Star Parties around the United States and Canada.

# GETTING STARTED

## Parts Listing

Getting the telescope ready for first observations requires only a few minutes. When first opening the packing box, note carefully the following parts:

- The ETX Astro Telescope with fork mount system.
- #494 Autostar handbox with attached coil cord.
- MA 25mm and MA 9mm eyepieces, each packed in a plastic storage container.
- Hex-wrench, packed with the instruction manual. See “GENERAL MAINTENANCE,” page 27.

## How to Assemble Your Telescope

Assembly of the ETX telescope requires only six AA-size (user-supplied) batteries and a few, simple steps:

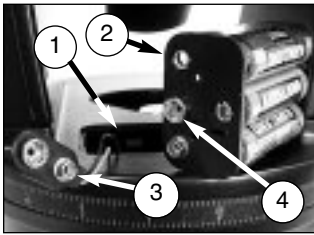

**Fig. 4:** View of the ETX telescope showing six AA-size batteries mounted inside the battery compartment:

- (1) Battery Compartment
- (2) Battery Holder
- (3) 9v Connector
- (4) Battery Holder Connector

1. The telescope's battery compartment (1, Fig. 4) is located on top of the drive base. Open the battery compartment by lifting the release latch and pulling it away from the drive base.
2. Remove the battery holder from the compartment and carefully lift the 9v connector out from the compartment. Take care not to accidentally detach the wires of the battery connector from the base. Whenever you replace the batteries, to safeguard the wires, disconnect the 9v connector from the battery holder before removing the batteries.
3. Insert six AA-size batteries into the battery holder, oriented as shown on the diagram on the battery slots of the battery holder. Insert the center battery on each side last for easier installation. Connect the 9v connector plug to the battery holder. Carefully replace the battery holder back into the battery compartment. Replace the cover.

**CAUTION:** Use care to install batteries as indicated by the battery compartment. Follow battery manufacturer's precautions. Do not install batteries backwards or mix new and used batteries. Do not mix battery types. If these precautions are not followed, batteries may explode, catch fire, or leak. Improperly installed batteries void your Meade warranty. Always remove the batteries if they are not to be used for a long period of time.

4. Be certain that the power switch on the computer control panel (10C, Fig. 1) is in the OFF position. Plug the coil cord of the Autostar Controller into the HBX port (10A, Fig. 1).

**NOTE:** Autostar does not require batteries; the telescope's batteries supply power to Autostar.

5. Remove the MA 25mm eyepiece (1, Fig. 1) from its container and place it in the eyepiece holder (3, Fig. 1). Tighten the thumbscrew (2, Fig. 1) to a "firm feel" only. Unscrew the dust cover counterclockwise to remove it from the telescope.

Basic assembly of the telescope is now complete.

## Choosing an Eyepiece

A telescope's eyepiece magnifies the image formed by the telescope's main optics. Each eyepiece has a focal length, expressed in millimeters, or "mm." The smaller the focal length, the higher the magnification. For example, an eyepiece with a focal length of 9mm has a higher magnification than an eyepiece with a focal length of 25mm.

Your telescope comes supplied with two standard eyepieces. The MA 25mm eyepiece gives a wide, comfortable field of view with high image resolution, while the MA 9mm eyepiece provides a smaller field of view but higher magnification when seeing conditions permit.

Low power eyepieces offer a wide field of view, bright, high-contrast images, and eye relief during long observing sessions. To find an object with a telescope, always start with a low power eyepiece such as the MA 25mm. When the object is located and centered in the eyepiece, you may wish to switch to a higher power eyepiece to enlarge the image as much as practical for prevailing seeing conditions.

**NOTE:** Seeing conditions vary widely from night-to-night and site-to-site. Turbulence in the air, even on an apparently clear night, can distort images. If an image appears fuzzy and ill-defined, back off to a lower power eyepiece for a more well-resolved image (Fig. 7a and 7b).



**Fig.5:** MA 25mm and MA 9mm eyepieces.

**NOTE:**

For a list of magnification ratings of the eyepieces available for the ETX-60AT and ETX-70AT telescopes, see "OPTIONAL ACCESSORIES," page 25.

The power, or magnification of a telescope is determined by the focal length of the telescope and the focal length of the eyepiece being used. To calculate eyepiece power, divide the telescope's focal length by the eyepiece's focal length. *E.g.*, a 25mm eyepiece is used with the ETX-60AT. The focal length of the ETX-60AT is 350mm (see "SPECIFICATIONS," page 29).

$$\text{Eyepiece Power} = \frac{\text{Telescope Focal Length}}{\text{Eyepiece Focal Length}} = \frac{350\text{mm}}{25\text{mm}} = 14\text{X}$$

The eyepiece power, or magnification is therefore 14x.

## Manual Operation of the Telescope without Autostar

If you wish to observe a distant land object, such as a mountain top or a bird, you can observe by merely pointing the telescope and looking through the eyepiece. Set the telescope on a table top or tripod, loosen the horizontal and vertical locks (**6 and 9, Fig. 1**), and turn the telescope towards the object you wish to observe. Sight along the top of the tube until you find the object. When the object appears in the eyepiece, focus the image using the by turning the focus knob (**8, Fig. 1**). Rotate the knob clockwise to focus on distant objects and counterclockwise to focus on nearby objects.

You can also observe stars and objects in the night sky using this method, but note that objects begin to slowly drift across the eyepiece field. This motion is caused by the rotation of the Earth. As you become familiar with Autostar operation, you can counteract the drift using the automatic tracking feature in the Setup menu (see "TO TRACK AN OBJECT AUTOMATICALLY," page 20), or by using Autostar's GO TO capabilities (see "GO TO SATURN," page 15).

## Manual Operation of the Telescope Using Autostar's Arrow Keys

You may also observe land and astronomical objects using Autostar's Arrow keys.

If you have not already done so, prepare your telescope following the steps described in "HOW TO ASSEMBLE YOUR TELESCOPE," page 10. Next, flip the On/Off Switch (**10, Fig. 1**) on the computer control panel to the ON position. The copyright message lights on Autostar's display. Press the Speed/? key (**8, Fig. 3**) to accept the Sun warning. The "Getting Started" message displays. Keep pressing the ENTER key (A) until "Country/State" appears on the display. (Ignore the prompts requesting "Date" and "Time" for now – these functions will be explained later in the manual).

Use the Scroll keys (D) to cycle through the database of countries/states. Press ENTER (A) when your location displays. Next, use the Scroll keys (D) to scroll to the nearest city to your observing site and press ENTER. Next, use the Scroll keys (D) to scroll to your telescope model and press ENTER. The display then reads "Setup: Align."

You can now use the Arrow keys (**5, Fig. 3**) to slew (move) the telescope up, down, right, or left. To change the telescope's slew speed, briefly press the Speed/? key (**8, Fig. 3**). Each press decreases the slew speed down one level, and then cycles back to the fastest speed. See page 22 for more information.

Tighten (to a "firm feel" only, do not over-tighten) the vertical and horizontal locks (**6 and 9, Fig. 1**). Sight along the side of the telescope's main tube to locate an object and practice using the Autostar's Arrow keys to center the object in the telescope's field of view. Use the telescope's focus knob (**8, Fig. 1**) to bring the object into focus.

This procedure demonstrates just a very small part of Autostar's capabilities. In the next section of this manual, you will begin to learn how to make use of Autostar's extensive and powerful features.



**Fig. 6:** Autostar's Arrow keys.

**NOTE:**

Autostar requests the Country/State, City, and Telescope Model information only the first time Autostar is activated. If you wish to change this information, use the "Site" and "Telescope Model" options in the Setup menu.

TIPS FOR BEGINNERS

### Too Much Power?

Can you ever have too much power? If the type of power you're referring to is eyepiece magnification, yes, you can! The most common mistake of the beginning observer is to "overpower" his or her telescope by using high magnifications which the telescope's aperture and atmospheric conditions can not reasonably support. Keep in mind that a smaller, but bright and well-resolved image is far superior to one that is larger, but dim and poorly resolved (see below). Powers above 110X should be employed only under the steadiest atmospheric conditions.

Autostar can calculate the best eyepiece for you to use. Try out the "Eyepiece Calc" feature in the Utilities menu.

Most observers should have three or four additional eyepieces to achieve the full range of reasonable magnifications possible with the ETX telescopes. See "OPTIONAL ACCESSORIES," page 25.

**Fig. 7a & b:** Jupiter; example of too much magnification.

## Moving Through Autostar's Menus

The Autostar database is organized in levels for quick and easy navigation.

- Press ENTER to go deeper into Autostar's menu levels.
- Press MODE to move back toward the top menu level.
- Press the Scroll keys to move up and down through the options available for each level.
- Press the Arrow keys to enter characters and digits.

The Arrow keys are also used to move the telescope.

## Initializing Autostar

This section describes how to initialize Autostar. Perform this procedure the first time you use Autostar or after performing a RESET. An example of this procedure is presented in "APPENDIX E," page 36.

1. Make sure that the vertical and horizontal locks (**6 and 9, Fig. 1**) are secured as described on page 5.
2. Verify that Autostar is properly connected to your telescope. See "HOW TO ASSEMBLE YOUR TELESCOPE," page 10.
3. Flip the telescope power switch to the ON position.

The Autostar screen is activated and a copyright message displays briefly, followed by a short beep. Then Autostar takes a few moments to start up the system.

4. A message displays that warns not to look at the Sun. At the end of this message, press the Speed/? key to signify that the message has been read and understood.
5. The Getting Started menu displays a scrolling message with two choices:
  - a. Hold down the Speed/? key (**8, Fig. 3**) for information on Autostar functions and controls. When finished, press MODE (**3, Fig. 3**) to exit Help and to return to the Getting Started procedure, or,
  - b. Press ENTER (**2, Fig. 3**) to bypass the Help tutorial and continue with initialization.
6. Autostar then requests the current date. Use the Up and Down Arrow keys (**5, Fig. 3**) to enter the digits for the date. Use the Right Arrow key (**5, Fig. 3**) to move from one number to the next in the day display, and also to move to the month. Then, use the Scroll keys (**6 and 7, Fig. 3**) to cycle through the list of months.

When the current month is displayed, use the Right Arrow (**5, Fig. 3**) to move to the year. Use the Up and Down Arrow keys to enter all four digits of the current year. Press ENTER when the date has been entered.

7. Autostar then requests the current time. Use the Up and Down Arrow keys to enter the time. (Use a "0" for the first digit if less than 10.) Use the Right (or Left) Arrow key to move from one number to the next. Press one of the Arrow keys (**5, Fig. 3**) to scroll to "AM" or "PM." If you select the "blank" choice that follows "AM" and "PM," the clock displays time in a 24-hour (military time) format. Then, press ENTER to start the clock.

**NOTE:** When multiple choices are available within a menu option, the current option is usually displayed first and highlighted by a right pointing Arrow (>).

8. The next screen requests the status of Daylight Savings Time. Pressing a Scroll key toggles between the YES/NO settings. Select the desired setting by pressing ENTER.

**NOTE:** Daylight Savings Time may be referred to by a different name in various areas of the world.

9. The next screen asks for the Country or State (listed alphabetically) of the observing site. Use the Scroll keys to cycle through the database of countries, states, and provinces. Press ENTER when the correct location displays.
10. The next screen asks for the city (listed alphabetically) closest to the observing site. Use the Scroll keys to cycle through the database of cities. Press ENTER when the correct city appears on screen.
11. The next screen asks for the telescope model. Use the Scroll keys to locate ETX-60 or ETX-70. Press ENTER to select the appropriate model.
12. System initialization is complete and the screen reads "Setup: Align".

*Initialization is a procedure that ensures that Autostar operates correctly. When you first use Autostar, it doesn't yet know where the observation location site is or the time or date of the observation session.*

*During the procedure, you will enter information, such as the current time and date, observation location, and telescope model. Autostar uses this information to precisely calculate the location of celestial objects (such as stars and planets) and how to move your telescope correctly for various operations.*

# AUTOSTAR OPERATION

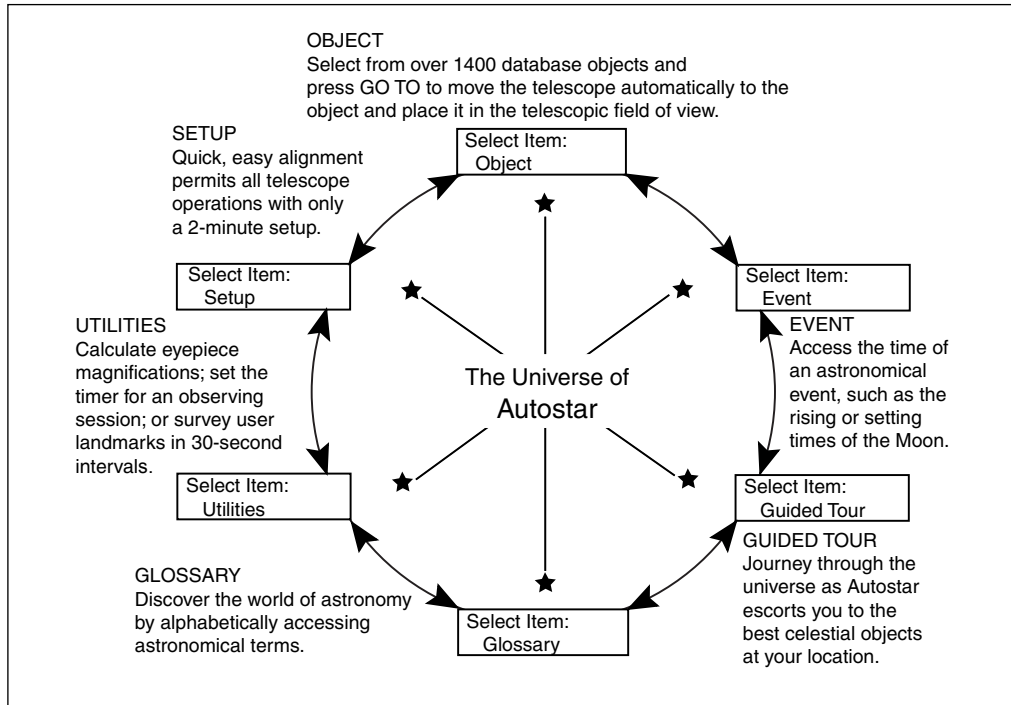

**Fig. 8:** The Autostar Universe: The six primary categories listed in the Select Item menu of Autostar.

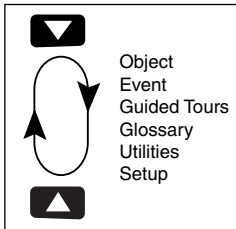

**Fig. 9:** Menus set in a loop.

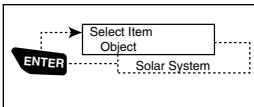

**Fig. 10:** Autostar levels.

It is important to understand that menu selections are set in a loop (**Fig. 9**). This means that pressing the Scroll Down key (**7, Fig. 3**) cycles down through all the available options within a given category, then returns to the first option. The Scroll Up key (**6, Fig. 3**) cycles up through the options in the opposite order. Note that this capability is a quick way to get to an option that is near the bottom of the list. The following example demonstrates this capability.

**Example:**

To navigate to the “Select Item: Setup” menu option when the “Select Item: Object” menu is displayed:

1. Press the Scroll Down key four times or the Scroll Up key once.

The screen in **Figure 10** displays two lines of information. The top line shows the current menu level. The second line displays an option which may be selected within that menu level. Some options are choices that select the next menu level down. The Scroll keys move up and down within the list of available options, showing one option at a time.

When the desired option is displayed on the second line, press the ENTER key to choose that option and move down one menu level.

Press the MODE key to leave a level; e.g., the wrong menu option is chosen.

**IMPORTANT NOTE:** No matter how many levels into Autostar are traveled, each press of the MODE key moves up a level, until the top level, “Select Item,” is reached. Once in the Select Item level, press MODE to return to the topmost level, “Select Item: Object.”

## Autostar Navigation Exercise

To demonstrate how the Autostar menu structure works, the following exercise calculates Sunset time so an evening observing session can be planned.

**NOTE:** To perform an accurate calculation, Autostar must be properly initialized with the current date, time, and location of the observing site. To enter the current date, time, and location information of your observing site, see “INITIALIZING AUTOSTAR,” page 12, before proceeding with this exercise.

**IMPORTANT NOTE:**

The "Telescope: Mount" option of the Setup menu is set to "Alt/Az" as the default alignment by the factory. The example presented in this section assumes that you are performing an alignment procedure for the first time with your telescope and therefore, the "Telescope: Mount" option does not need to be selected. For information on equatorial (Polar) alignment, see "APPENDIX A," page

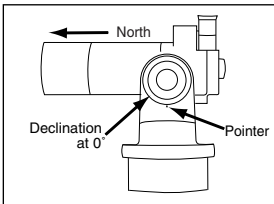

**Fig. 11:** Alt/Az Alignment Home Position.

**NOTE:**

The GO TO key also allows you to perform a "spiral search." A spiral search is useful when the telescope slews to an object, but that object is not visible in the eyepiece after the telescope finishes its search. (This sometimes occurs during an alignment procedure.) Press GO TO when the slew is finished and the telescope starts slewing in a spiral pattern at a very slow speed around the search area. Look through the eyepiece and when the object does become visible, press MODE to stop the spiral search. Then use the Arrow keys to center the object.

**To Calculate Sunset time:**

1. Press the MODE key several times, until "Select Item: Object" is displayed.
2. Press the Scroll Down key once to display the "Event" option in the "Select Item" menu.
3. Press the ENTER key to choose the "Event" option and move down a level. "Event: Sunrise" is displayed.
4. Press the Scroll Down key once to display the "Sunset" option in the Event menu.
5. Press the ENTER key to choose the "Sunset" option and move down another level.
6. Autostar calculates the Sunset time based on the current date, time, and location. Autostar then displays the results of the calculation.
7. Press MODE once to start moving back up through the Autostar levels. The first level up is the Event menu.
8. Press MODE again to move up another level. This is the top level, "Select Item."
9. Press MODE again to return to the starting point of "Select Item: Object."

**Easy Two-Star Alignment**

The fastest and easiest way to start observing with Autostar is to use Easy Two-Star Alignment.

Autostar automatically picks two stars from its database for the Easy Two-Star Alignment procedure. During the Easy Alignment procedure, Autostar slews the telescope to a first alignment star. The user is asked to verify that the telescope is pointed at the chosen star and then to center the star in the eyepiece. The process is repeated with a second star to complete the alignment.

**NOTE:** Before aligning the telescope, first verify that "INITIALIZING AUTOSTAR," page 12, has been performed. See "MOVING THROUGH AUTOSTAR'S MENUS," page 12, for a description of how Autostar's keys operate.

**Easy Two-Star Alignment Procedure:**

1. **Sun Warning** - Press the Speed/? key to accept.
2. **Getting Started** - Press ENTER to continue, or the Speed/? key to access the Autostar Help tutorial. Press MODE to leave the tutorial at any time.
3. **Enter Date** - Enter the current date, then press ENTER.
4. **Enter Time** - Enter the current time. Select "AM," "PM," or 24-hour clock (blank). Then press ENTER.
5. **Daylight Savings** - Select "Yes" or "No," then press ENTER.
6. **Alignment Option Screen** - "Setup: Align" displays. Press ENTER.
7. **Select Alignment** - "Align Easy" displays. Press ENTER.
8. **Set Home Position** - Autostar then prompts you to set the telescope in the Alt/Az Alignment home position. To set your telescope in the "Alt/Az" home position:
  - Loosen the telescope's vertical lock (**6, Fig. 1**).
  - Level the optical tube by lining up 0° on the Dec setting circle (**17, Fig. 1**) with the pointer (**Fig. 13**).
  - Tighten the vertical lock (**6, Fig. 1**) to a "firm feel" only.
  - Unlock the horizontal lock (**9, Fig. 1**) and turn the telescope horizontally until it points North. Re-lock the horizontal lock (**9, Fig. 1**).
  - Press ENTER. See "ALT/AZ HOME POSITION," page 21, for more information.
9. **Star Alignment** - The Autostar then chooses two stars to align upon. When the telescope slews to the first star for alignment, it may not appear in the field of view in the eyepiece. The alignment star should be easily recognized and be the brightest star in the area of the sky where the telescope is pointing. Use the Arrow keys to move the telescope until the star is visible and centered in the eyepiece. Press ENTER. Repeat procedure for the second alignment star.

**NOTE:** Autostar locates alignment stars based on the date, time, and location entered. The alignment stars may change from night to night. All that is required is for the observer to center the selected stars in the eyepiece when prompted.

# OBSERVING EXERCISES

## Go To Saturn

**NOTE:**

Keep in mind that when viewing through the eyepiece, images of terrestrial objects are right-side-up, but reversed left-for-right. Normally, such an image orientation is not bothersome, unless trying to read a distant sign, for example.

If the telescope is to be used for extensive terrestrial observations, a correctly oriented image is provided with the #933 45° Erecting Prism. See "OPTIONAL ACCESSORIES," page 25.

After performing the Easy Two-Star Alignment procedure, the motor drive begins operating and the telescope is aligned for a night of viewing. Objects in the eyepiece should maintain their position even though the Earth is rotating beneath the stars.

**IMPORTANT NOTE:** Once aligned, only use the GO TO or Arrow keys to move the telescope. Do not loosen the telescope locks (6 and 9, Fig. 1), or move the base manually, or alignment will be lost.

This exercise demonstrates how to select an object for viewing from Autostar's database. This example demonstrates how to select Saturn.

**NOTE:** Saturn is not visible the entire year and you may need to choose another object from Autostar's database; however, the procedure, as described below, remains the same.

1. After the telescope is aligned, "Select Item: Object" displays. Press ENTER.
2. "Object: Solar System" displays. Press ENTER.
3. "Solar System: Mercury" displays. Keep pressing the Scroll Down key until "Solar System: Saturn" displays.
4. Press ENTER. "Calculating" displays. Then "Saturn" and a set of coordinates displays. Saturn's (and other planets') coordinates change throughout the year.
5. Press GO TO. "Saturn: Slewing..." displays and the telescope slews until it finds Saturn. You may need to use the Arrow keys to center Saturn precisely in the eyepiece. Autostar then automatically slews (moves) the telescope so that it "tracks" Saturn (or whatever other object you may have chosen); *i.e.*, Saturn remains centered in the eyepiece. If an object is observed in the telescope without using Autostar's GO TO or automatic tracking capabilities (see "TO TRACK AN OBJECT AUTOMATICALLY," page 20), objects in the eyepiece gradually drift out of the field of view due to the Earth's rotation.

## Using the Guided Tour

This example demonstrates using "Tonight's Best" Guided Tour.

1. After observing Saturn, press MODE twice so that "Select Item: Object" displays again.
2. Press the Scroll Down key twice. "Select Item: Guided Tour" displays.
3. Press ENTER. "Guided Tour: Tonight's Best" displays. Press ENTER.

**NOTE:** If you wish to try out other Guided Tours, press the Scroll Down key to scroll through other tour choices. When the tour you wish to select displays, press ENTER.

4. "Tonight's Best: Searching..." displays. After calculating, "Tonight's Best: Jupiter" displays.

**NOTE:** Different objects may be displayed on a tour list on any given night.

Press ENTER or Speed/? to display information about the object. Press GO TO to move the telescope to the object.

5. Press MODE to return to the Tour list. Press the Scroll keys to scroll through the list. Press ENTER when you find the next object you wish to observe.
6. Press MODE repeatedly to leave the Guided Tour menu.

 **TIPS FOR BEGINNERS** 

### Which One's the Alignment Star?

If Autostar has chosen an alignment star with which you are unfamiliar, how can you be sure if the star in your eyepiece is really the alignment star?

The rule of thumb is that an alignment star is usually the brightest star in that area of the sky. When you view an alignment star in an eyepiece, it stands out dramatically from the rest of the stars in that portion of the sky.

If you have an obstruction, such as a tree or a building blocking your view of the alignment star, or if you have any doubts at all about the star that has been chosen, no problem. Just press the Scroll Down key and Autostar will find another star to align upon.

# AUTOSTAR MENUS

## The Complete Autostar Menu Structure

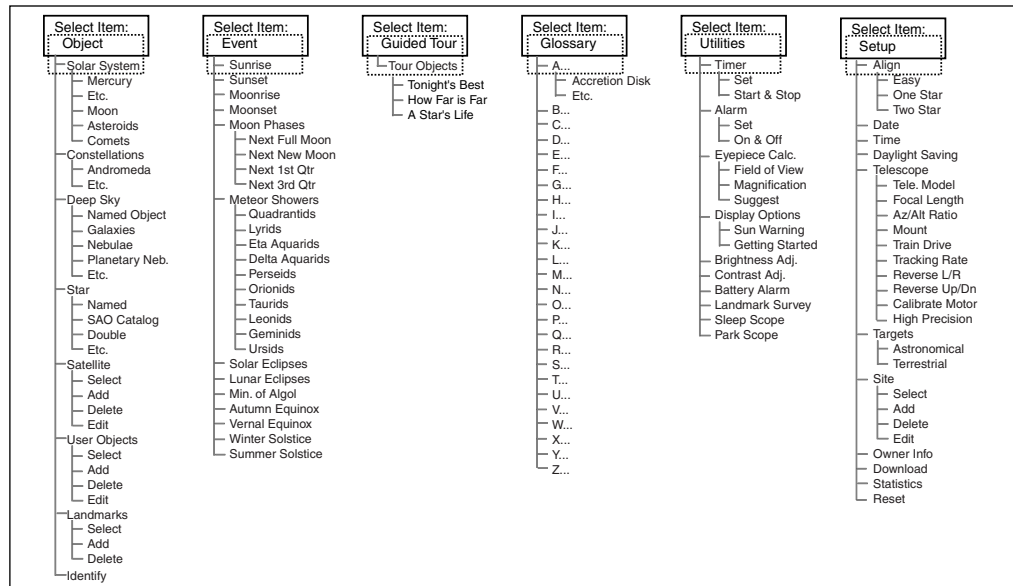

### Object Menu

Almost all observing with Autostar is performed using the Object menu category. (**NOTE: Exceptions include Guided Tour and Landmark Survey.**) See “GO TO SATURN,” page 15, for an example of observing using the Object menu. Also see “USING THE GUIDED TOUR,” page 15.

Many Autostar menu categories contain databases. An Autostar **database** is a list of viewable objects, such as stars, planets, comets, nebulae and so forth. When one of these objects is selected, Autostar moves your telescope (if properly aligned) and points it at the selected object.

The Object Menu functions include:

**Solar System** is a database of the eight planets (Earth is not included) in order out from the Sun, followed by the Moon, asteroids, and comets.

**Constellation** is a database of all 88 Northern and Southern Hemisphere constellations. When this menu option is chosen and a constellation name appears on the first line of the screen, press GO TO once to change the second line to the name of the brightest star in the constellation. Press GO TO a second time to slew the telescope to that star. Use the Scroll keys to cycle through the list of stars in the constellation, from brightest to dimmest.

**Deep Sky** is a database of objects outside our Solar System such as nebulae, star clusters, galaxies, and quasars.

**Star** is a database of stars listed in different categories such as named, double, variable, or nearby.

**Satellite** is a database of Earth-orbiting objects such as the International Space Station, the Hubble Space Telescope, Iridium, Global Positioning System satellites, and geosynchronous orbit satellites. See “OBSERVING SATELLITES,” page 23.

**User Objects** allows the user to define deep-sky objects of specific interest that are not currently in the Autostar database. See “APPENDIX B,” page 33, for more information.

Use the **Landmark Survey** option in the Utilities menu to sequentially view all Landmarks entered into Autostar.

**Landmarks** stores the location of terrestrial points of interest in the permanent Autostar database.

**IMPORTANT NOTE:** To use the Landmark function, the telescope must be located and aligned exactly as when the landmark was added to the database. Additionally, the telescope needs to be mounted in the same configuration, i.e., Alt/Az or Polar.



- **Select** - To select a Landmark already in the database, choose the "Select" option and scroll through the list. Press ENTER to select a Landmark, then press GO TO and the telescope slews to the object.
- **Add** - To add a Landmark, choose the "Add" option. Enter a name for the Landmark. Locate and center the Landmark, then press ENTER.

**Identify** is an exciting feature for an observer who wants to scan the night sky and start exploring. After the telescope has been properly aligned, use the Autostar Arrow keys to move about in the sky. Then follow this procedure:

**IMPORTANT NOTE:** *Only use the Arrow keys to move the telescope during the Identify procedure. Do not loosen the telescope locks or move the base. Alignment is lost.*

1. When a desired object is visible in the eyepiece, keep pressing MODE until the "Select Item: Object" menu is displayed.
2. Scroll through the Object menu options until the "Object: Identify" screen appears.
3. Press ENTER. Autostar searches the database for the identity of the object being observed.
4. If the telescope is not directly on an Autostar database object, the nearest database object is located and displayed on the screen. Press GO TO and the telescope slews to that object.

## Event Menu

The Event menu provides access to dates and times of astronomical events. The Event database includes:

**Sunrise** and **Sunset** calculates the time that the Sun rises or sets on the current date. Find rise and set times for other dates by entering a new date into the "Setup: Date" menu.

**Moonrise** and **Moonset** calculates the time that the Moon rises or sets on the current date. Find rise and set times for other dates by entering a new date into the "Setup: Date" menu.

**Moon Phases** displays the date and time of the next Full, New, 1st Quarter, and 3rd Quarter Moon.

**Meteor Showers** provides information on upcoming meteor showers, such as the Perseids, the Leonids, *etc.* Also lists the dates of the showers and when they reach maximum.

**NOTE:** *Meteors are fast moving objects that cover large areas of the sky and are usually best observed with the naked eye.*

**Solar Eclipse** lists upcoming Solar Eclipses, including the date and type (total, annular, or partial) of eclipse, and the location and time of the first and last contacts of the Moon's shadow. Use the Scroll Up and Down keys to display the available data. Remember, never use a telescope to look at the sun! See "WARNING!" page 2.



### TIPS FOR BEGINNERS



- Try to pick an observing site away from street and house lights and car headlights. While this is not always possible, the darker the site, the better.
- Give your eyes about ten minutes to adjust to the darkness before observing. Give your eyes a rest from observing every ten or fifteen minutes to relieve eyestrain.
- Try not to use a standard flashlight. A lot of observers use red LED flashlights or tape red cellophane over their flashlights to use for setup and map reading so they don't have to continually readjust their eyes to the darkness. Be careful not to shine bright lights if there are other observers in the area. Do not shine a flashlight into the telescope while someone is observing!
- Dress warmly. It gets chilly when you're sitting for prolonged periods.
- Practice setting up your equipment during the day or in a lighted area to become familiar with it before going to a dark site.
- Use your 25mm eyepiece to view terrestrial objects and wider areas of space, such as open star clusters. Use your 9mm eyepiece when you wish to view something up close, such as craters on the Moon or the rings of Saturn.
- Know your observing site. If you're going to try out an unfamiliar site, check it out in the daylight for possible obstructions and pitfalls.

**Lunar Eclipse** lists upcoming Lunar Eclipses, including the date and type (total, partial, penumbral) of eclipse. Use the Scroll Up and Down keys to display the available data.

**Min. (Minimum) of Algol** is the minimum brightness of the dramatic eclipsing binary star system, Algol. It is relatively close at a distance of 100 light years. Every 2.8 days during a 10-hour period, Algol undergoes a major change in apparent magnitude as one of the two stars passes behind the other. The combined magnitude of the two stars thus dips from +2.1 to a minimum of +3.4 halfway through the eclipse as the second star is hidden. Autostar calculates minimum magnitude time at mid-eclipse.

**Autumn** and **Vernal Equinox** calculates the time and date of the fall or spring equinox of the current year.

**Winter** and **Summer Solstice** calculates the time and date of the winter or summer solstice of the current year.

## Glossary Menu

The Glossary menu provides an alphabetical listing of definitions and descriptions for common astronomical terms and Autostar functions. Access directly through the Glossary menu or through hypertext words embedded in Autostar. A **hypertext word** is any word in [brackets], usually found when using the Autostar Help function or when reading a scrolling message such as a description of a planet or star. Press ENTER whenever a hypertext word is on screen and Autostar links directly to the glossary entry for that word.

To access directly from the Glossary menu, use the Scroll keys to scroll through the alphabet. Press ENTER on the desired letter. Scroll to the desired entry, then press ENTER to read the description.

## Utilities Menu

The Utilities menu provides access to several extra features within Autostar, including a countdown timer and an alarm. The Utilities functions include:

**Timer** selects a countdown timer. This feature is useful for functions such as astrophotography and tracking satellites. See "OBSERVING SATELLITES," page 23. To use the Timer, press ENTER, then choose "Set" or "Start/Stop".

- **Set:** Enter the time to be counted down, in hours, minutes, and seconds, then press ENTER.
- **Start/Stop:** Activates the timer set previously. Use the Scroll keys to toggle between ON and OFF. When ON is displayed, press ENTER to activate the timer. When the timer runs out, four beeps sound and the timer is deactivated.

**Alarm** selects a time for an alarm signal as a reminder. To use the Alarm, press ENTER, then choose "Set" or "Start/Stop."

- **Set:** Enter the time of day for the alarm to sound, in hours, minutes, and seconds, then press ENTER.
- **Start/Stop:** Activates the alarm set previously. Use the Scroll keys to toggle between ON and OFF. When ON is displayed, press ENTER to activate the alarm. When the alarm time arrives, Autostar beeps. Press ENTER to deactivate the alarm.

**Eyepiece Calc** calculates information about an eyepiece for the specific telescope to which Autostar is connected.

- **Field of View:** Scroll through a list of available eyepieces. When an eyepiece is selected, the field of view is calculated.
- **Magnification:** Scroll through a list of available eyepieces. When an eyepiece is selected, the magnification is calculated.
- **Suggest:** Autostar calculates and suggests the best eyepiece for viewing, based on the telescope and the object being viewed.

**Display Options** enables or disables Autostar's two initial displays. If both displays are disabled, Autostar begins with the Date display.

- **Sun Warning:** Turns the "Sun Warning" message on or off.
- **Getting Started:** Turns the "Getting Started" message on or off.

**Brightness Adj:** Adjusts the brightness of the display using the Scroll keys. When complete, press ENTER.

**Contrast Adj:** Adjusts the contrast of the display using the Scroll keys. When complete, press ENTER.

**NOTE:** This feature is usually only required in very cold weather.

**Landmark Survey** automatically slews the telescope to all user-defined landmarks with a short pause at each location. Press ENTER to start the survey. While a slew is in progress, press any key to skip that object and go to the next landmark on the list. To observe a landmark for a longer period, press MODE when paused on the object to stop the survey. Press ENTER to restart the survey at the first object on the list. See "Landmark," page 16.

**Sleep Scope** is a power saving option that shuts down Autostar and the telescope without forgetting its alignment. With "Sleep Scope" selected, press ENTER to activate the Sleep function. Autostar goes dark, but the internal clock keeps running. Press any key, except ENTER, to re-activate Autostar and the telescope.

**Park Scope** is designed for a telescope that is not moved between observing sessions. Align the telescope one time, then use this function to park the telescope. Next time it is powered up, enter the correct date and time - no alignment is required. Pressing ENTER causes the telescope to move to its pre-determined Park position. Once parked, the screen prompts to turn off power.

**IMPORTANT NOTE:** When the "Park Scope" option is chosen and the display prompts you to turn off the telescope's power, Autostar is unable to be returned to operation without turning the power off and then back on.

## Setup Menu

The Setup menu's primary function is to align the telescope (see pages 14 and 21). However, there are numerous other features available within the Setup menu, including:

**Date** changes the date used by Autostar. This function is useful to check events in the past or future. For example, set the Date menu for a day three months in the future. Then check the "Select Item: Event" menu for the Sunset time on that date. See "EVENT MENU," page 17.

**Time** changes the time entered into Autostar. Setting the correct time is critical for Autostar to properly calculate locations and events. Time may be set to 24-hour mode (military time) by selecting the "blank" option which follows the "AM" and "PM" options.

**Daylight Saving** is used to enable or disable Daylight Savings time.

**NOTE:** Daylight Savings Time may be referred to by different names in various areas of the world. Check local time to verify.

**Telescope** accesses the several options, including:

- **Telescope Model:** Selects the model of telescope connected to Autostar.
- **Focal Length:** Displays the focal length of the selected telescope.
- **Az Ratio and Alt Ratio:** The Az (Azimuth) ratio and Alt (Altitude) ratio refers to the gears of the telescope's motors. Do not alter these numbers.
- **Mount:** Choose between Alt/Az mount or Polar Mount. Mount requires that the telescope be physically aligned to the mount selected in this menu. The default setting is "Alt/Az."



**TIPS FOR BEGINNERS**

### Surf the Web

One of the most exciting resources for astronomy is the internet. The internet is full of websites with new images, discoveries, and the latest astronomical information. For example, when comet Hale-Bopp made its approach to our Sun in 1998, astronomers around the world posted new photos daily.

You can find websites for almost any topic relating to astronomy on the internet. Try the following key word searches: NASA, Hubble, HST, astronomy, Messier, satellite, nebula, black hole, variable stars, etc.

Check out Meade's website for the latest product and technical information. You can download the latest software revisions, links to other astronomical sites, coordinates of celestial objects and the latest satellite tracking information for your #494 Autostar handset. See page 20 for more information. You'll find our website at:

<http://www.meade.com/>

Here are some other sites you might find interesting:

- **Sky & Telescope:**  
<http://www.skypub.com/>
- **Astronomy:**  
<http://www2.astronomy.com/astro/>
- **The Starfield:**  
<http://users.nac.net/gburke/>
- **Astronomy Picture of the Day:**  
<http://antwrp.gsfc.nasa.gov/apod/>
- **Heaven's Above (satellite observing information):**  
<http://www.heavens-above.com/>

- **Train Drive:** Trains the altitude and azimuth motors to locate objects with more precision. If you are experiencing any problems with pointing accuracy, follow the procedure described in "APPENDIX D: TRAINING THE DRIVE," page 35, to insure accurate pointing and tracking.
- **Tracking Rate:** Changes the speed at which the telescope tracks targets in the sky.
  - a. **Sidereal:** The default setting for Autostar; sidereal rate is the standard rate at which stars move from East to West across the sky due to the rotation of the Earth.
  - b. **Lunar:** Choose this option to properly track the Moon over long observing sessions.
  - c. **Custom:** Allows entry of user-defined tracking rates.
- **Reverse L/R:** Reverses the functions of the Left and Right Arrow keys (*i.e.*, the Right key moves the telescope to the left).
- **Reverse UP/DOWN:** Reverses the functions of the Up and Down Arrow keys (*i.e.*, the Up key moves the telescope down).
- **Calibrate Motor:** If the telescope motors appear to have a problem, use this option to retest the motors before doing a Reset. This option is also used if an Autostar unit is moved between telescopes to match Autostar to the telescope.
- **High Precision:** If High Precision is turned on, when looking for a faint celestial object (*i.e.*, a nebula or galaxy), Autostar first slews to a nearby bright star and displays "ENTER to Sync." Center the star in the eyepiece, then press ENTER. At that point the telescope has a high precision alignment to that part of the sky and it then slews to the object that was originally requested.

**IMPORTANT NOTE:**

While performing the automatic tracking procedure, only use the Arrow keys to move the telescope. Once the telescope has been set in the Alt/Az home position, do not loosen the telescope locks (6 and 9, Fig. 1), or move the base manually, or alignment will be lost.

**Targets** switches between **Astronomical** targets and **Terrestrial** targets. If Astronomical targets are selected, the telescope tracking motor is activated and objects you're observing will remain centered in the eyepiece. If Terrestrial targets are selected, the tracking motor is turned off.

**To track an object automatically,** set the telescope in the Alt/Az home position (see "EASY TWO-STAR ALIGNMENT PROCEDURE, step #8", page 14), locate an object you wish to observe using Autostar's Arrow keys (see page 11), and center the object in the eyepiece. Then scroll to the "Targets: Astronomical" menu display and press ENTER. Autostar then automatically slews (moves) the telescope to keep the object centered in the eyepiece.

**Site** provides access to several options including:

- **Select:** Displays the currently selected observing site and also allows you to select other sites you have entered into a user-defined database (see "Add" below). Use the Scroll keys to cycle through all available sites in this database. Press ENTER when the site you wish to select displays. Use this option when you move to a different geographic location.

*NOTE: Only the site that is entered during Initialization (see page 16) will be displayed until other sites are entered with the "Add" option.*

- **Add:** Allows you to add a new observing site to the database (up to six sites may be stored). Scroll through the list of Countries/States. Press ENTER when the site you wish to add displays. Then choose the desired city in the same manner.
- **Delete:** Deletes a stored site from the database.
- **Edit:** Edits a selected site, including: the name, latitude, longitude, and time zone. Time Zone refers to the Greenwich Mean Time (GMT) time zone shift. Users West of Greenwich, England use "-" hours, East of Greenwich use "+" hours. For the United States, look up the time zone shift in Table 1.

*NOTE: Autostar compensates for daylight savings time, if selected. See "Setup Menu: Daylight Saving," page 19.*

**Owner Info** accesses the owner information menu, including:

- **Name:** Users may enter both their first and last names using the Up and Down Arrow keys to cycle through the alphabet. Use the Right and Left Arrow keys to move through the text. Press ENTER when the entry is complete.
- **Address:** Use the Up and Down Arrow keys to enter your street address, city, state, and zip code. Press ENTER when the entry is complete.

**Download** transfers information from a personal computer or another Autostar. During the operation, the warning "Downloading Do Not Turn Off" appears.

**Statistics** provides basic statistical data about Autostar, including:

- **Characters Free:** Shows how much room is available in user-defined object memory.
- **Version:** Shows the current version of the Autostar software.

**Reset** completely resets Autostar. Autostar requires initialization again after a Reset before proceeding with observations. See "INITIALIZING AUTOSTAR," page 12. You also need to perform "TRAINING THE DRIVE," page 35.

Time Zone	Shift
Atlantic	-4 Hours
Eastern	-5 Hours
Central	-6 Hours
Mountain	-7 Hours
Pacific	-8 Hours
Hawaii	-10 Hours

Table 1: Time Zone Shift.

**NOTE:**

The Download function requires the optional #506 Astrofinder Software and Cable Connector Kit. See the instruction sheet included with the kit for more information on how to download. Also see "OPTIONAL ACCESSORIES," page 25.

# ADVANCED FEATURES

## Terrestrial Observing

The ETX-60AT and ETX-70AT make excellent high-resolution, terrestrial (land) telescopes. Viewing terrestrial objects requires looking along the Earth's surface through heat waves. These heat waves often cause degradation of image quality. Low power eyepieces, like the MA 25mm eyepiece, magnify these heat waves less than higher power eyepieces. Therefore, low power eyepieces provide a steadier, higher quality image. If the image is fuzzy or ill-defined, reduce to a lower power eyepiece, where the heat waves do not have such an effect on image quality. Observing in early morning hours, before the ground has built up internal heat, produces better viewing conditions than during late afternoon hours.

## Astronomical Observing

Used as an astronomical instrument, your telescope has many optical and electromechanical capabilities. It is in astronomical applications where the high level of optical performance is readily visible. The range of observable astronomical objects is, with minor qualification, limited only by the observer's motivation.

## Sidereal Rate

As the Earth rotates beneath the night sky, the stars appear to move from East to West. The speed at which the stars move is called the sidereal rate.

If the telescope is aligned, the motor drive is designed to rotate the telescope at the sidereal rate so that it automatically tracks the stars. This tracking makes it easy to locate objects and keep them centered in the telescope's eyepiece.

## Alignment (Mount)

The telescope's mount permits the movement of the telescope in both Altitude (vertically) and Azimuth (horizontally). In order to automatically track a celestial object, the mount must be properly aligned. Easy Two-Star Alt/Az Alignment is described on page 14.

## Alt/Az Alignment

One-Star Alt/AZ Alignment or Two-Star Alt/AZ Alignment allows you to choose the alignment stars during the alignment procedure. The stars are chosen from Autostar's database of alignment stars. The database displays after One-Star Alt/Az or Two-Star Alt/Az Alignment is selected. .

The term "Alt/Az." is frequently used to refer to the Altitude or horizontal and Azimuth or vertical movements of the ETX-60AT and ETX-70AT telescopes. Other terms to describe a telescope's movement may be used with telescopes that have mounts different from the ETX-60AT and ETX-70AT.

## Alt/Az Home Position

To set your telescope in the "Alt/Az" home position:

- Set the telescope on a flat level surface, such as a tabletop, or by mount it on the optional #882 tripod
- Loosen the telescope's vertical lock (**6, Fig. 1**).
- Level the optical tube by lining up 0° on the Dec setting circle (**17, Fig. 1**) with the pointer (**Fig. 13**).
- Tighten the vertical lock (**6, Fig. 1**) to a "firm feel" only.
- Unlock the horizontal lock (**9, Fig. 1**) and turn the telescope horizontally until it points North. Learn the position of Polaris, the North Star, which lies due North (**Fig. 20**). A small pocket compass may be useful
- Re-lock the horizontal lock (**9, Fig. 1**).
- Press ENTER.



**Fig. 12:** Tripod set in Alt/Az Configuration on optional #882 tripod.

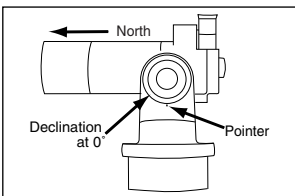
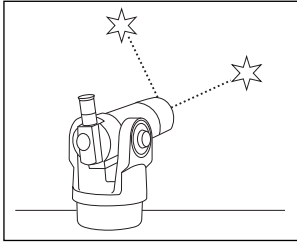

**Fig. 13:** Alt/Az Home Position.

## Two-Star Alt/Az Alignment

**Level:** Beginner/Intermediate

Two-Star Alignment requires some knowledge of the night sky. Autostar provides a database of bright stars and two stars from this database are chosen by the observer for alignment.



**Fig. 14:** Alt/Az Two-Star Alignment.

1. **Perform steps 1 through 8** as described in the "EASY TWO-STAR ALIGNMENT PROCEDURE," page 14.
2. **Align to the first star.** Autostar then displays a database of stars for the observer to choose from. Use the Scroll keys to scroll to a star that you wish to align upon. Select a star that you can easily locate in the night sky.
3. **Press ENTER.** The telescope slews to the star for alignment. Use the Arrow keys to move the telescope until the star is visible and centered in the eyepiece.
4. **Press ENTER.** Repeat procedure for the second alignment star. The telescope is aligned and you are now ready to use Autostar's GO TO capabilities for a night of observing.

## One-Star Alt/Az Alignment

**Level:** Intermediate

One-Star Alignment requires some knowledge of the night sky. Autostar provides a database of bright stars. One-Star Alignment is identical to Two-Star Alt/Az: Alignment (see "TWO-STAR ALT/AZ ALIGNMENT," above), except only one star from this database is chosen by the observer for alignment.

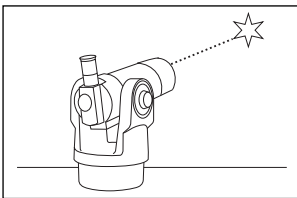

**Fig. 15:** Alt/Az One-Star Alignment.

**IMPORTANT NOTE:** The accuracy of One-Star Alt/Az Alignment, unlike the Two-Star Alt/Az Alignment procedure, depends on how well the observer levels the telescope and how close to North the telescope is pointed when setting the Home Position (Fig. 12). Because Two-Star Alignment uses two stars to align upon, it is more precise than One-Star Alignment.

## Slew Speeds:

Autostar has nine slew speeds that are directly proportional to the sidereal rate and have been calculated to accomplish specific functions. Pressing the Speed/? key briefly changes the slew speed, which is shown for about two seconds on Autostar's display.

**NOTE:** Pressing the Speed/? key very briefly changes the slew speed. Holding down the Speed/? key longer (one to two seconds) accesses the Help function.

The nine available speeds are:

Speed 1	=	5°	=	1200 x sidereal (300 arc-min/sec or 5°/sec)
Speed 2	=	2°	=	480 x sidereal (120 arc-min/sec or 2°/sec)
Speed 3	=	1°	=	240 x sidereal (60 arc-min/sec or 1°/sec)
Speed 4	=	0.5°	=	120 x sidereal (30 arc-min/sec or 0.5°/sec)
Speed 5	=	64x	=	64 x sidereal (16 arc-min/sec or 0.27°/sec)
Speed 6	=	32x	=	32 x sidereal (8 arc-min/sec or 0.13°/sec)
Speed 7	=	16x	=	16 x sidereal (4 arc-min/sec or 0.067°/sec)
Speed 8	=	8x	=	8 x sidereal (2 arc-min/sec or 0.033°/sec)
Speed 9	=	2x	=	2 x sidereal (0.5 arc-min/sec or 0.008°/sec)

**Speed 1:** Moves the telescope quickly from one point in the sky to another

**Speeds 2 or 3:** Best used for rough centering of an object in the eyepiece.

**Speeds 4, 5, or 6:** Enables centering an object in the field of a low-to-moderate power eyepiece, such as the standard MA 25mm.

**Speeds 7, 8, or 9:** Best used for fine centering of an object in the field of view of a high power eyepiece, such as the standard MA 9mm or higher powers.

## Observing a Satellite

**NOTE:** *Satellite observing is an exciting challenge. Most satellites are in low orbit, traveling at approximately 17,500 mph. They move quickly across the sky and are visible only for a few minutes, requiring Autostar to slew the telescope rapidly. Best viewing is near Sunrise or Sunset when the sky is still dark. Viewing in the middle of the night can be problematic because the satellite may pass overhead, but not be visible as it is in the Earth's shadow.*

1. Choose a satellite from the Select menu, then press ENTER. Autostar scans its database to find if that satellite is expected to pass overhead within the next 6 hours.
2. If a satellite is expected, use the Scroll keys to access a list of information about the pass, including acquisition time, location, etc.
3. At the end of the list is "Alarm." Press ENTER and Autostar automatically sets the alarm to sound several minutes before the scheduled appearance. You may return to regular observations until the alarm goes off.
4. When the alarm goes off, return to the Satellite menu and press a Scroll key until the desired satellite is on the top line of the display.
5. Press GO TO. Autostar slews the telescope to where the satellite should appear. The motor drive stops and a countdown starts.

**NOTE:** *If the scheduled appearance position of the satellite is obstructed (i.e., by a building, tree, or hill), press ENTER and Autostar starts to move the telescope along the expected satellite track. When the track clears the obstruction, press ENTER again to pause the telescope, then continue with this procedure.*

6. With about 20 seconds left on the countdown timer, start watching through the eyepiece for the satellite to enter the field of view.
7. When the satellite enters the field of view, press ENTER. The telescope starts to track with the satellite.
8. Use the Arrow keys to center the object in the eyepiece to view the object. Satellite orbits change and new satellites (including the Space Shuttle) are launched. Visit the Meade website ([www.meade.com](http://www.meade.com)) approximately once a month to get updated information and instructions on how to download this data to Autostar. If orbital parameters are more than one month old, the satellite pass may not happen at the time predicted by Autostar. To download new satellite data into Autostar memory requires the optional Astrofinder Software and Cable Connector Kit. See "OPTIONAL ACCESSORIES," page 25.

## Photography with the ETX

Photography through the ETX-60AT or ETX-70AT requires the addition of the optional #64ST T-Adapter. See "OPTIONAL ACCESSORIES," page 25. With the #64ST T-Adapter attached to the telescope (**Fig. 17**), through-the-telescope photography is possible with any 35mm camera body with a removable lens. In this way, the telescope effectively becomes the lens of the camera.

For through-the-telescope photography, turn the flip-mirror control (**15, Fig. 1**) to the "down" position, allowing light to pass straight through the telescope and out the photo port (**16, Fig. 1**). With the flip-mirror control in the "down" position and the photo port's dust cover removed, the front lens of the telescope can be seen when looking through the photo port. The #64ST T-Adapter (**1, Fig. 17**) threads on to the photo port, followed by a T-Mount (**2, Fig. 17**) for the particular brand of 35mm camera being used, followed by the camera body (**3, Fig. 17**).

To frame an object in the viewfinder of the 35mm camera body, use a small jeweler's screwdriver to slightly loosen three adjustment screws (**4, Fig. 17**) around the outer knurled ring of the T-Mount. Rotate the camera body to achieve proper framing of the object; then re-tighten the adjustment screws.

The #64ST T-Adapter permits close-coupling of a camera body to the telescope at a focal length of 350mm and an effective photographic speed of f/5.8 for the ETX-60 and f/5 for the ETX-70. In this format vignetting occurs: the photographic image appears on film with a slight darkening (vignetting) at the corners of the 35mm frame (Fig. 16).



**Fig. 16:** Example of vignetting.

When removing the T-Adapter and T-Mount from the photo port, the T-Adapter may become torqued to either the photo port or the T-Mount. If this occurs, the T-Adapter has a slot on both sides which may be used to loosen the T-Adapter. Place a metal straight edge, or similar instrument across the two slots and turn counterclockwise to remove the T-Adapter. Photography through a long lens such as the ETX-60AT or ETX-70AT requires special technique for good results, and the photographer should probably expect to waste a roll or two of film in acquiring this technique. Long-lens photography has its own rewards, however, rewards that short-focus lenses cannot duplicate.

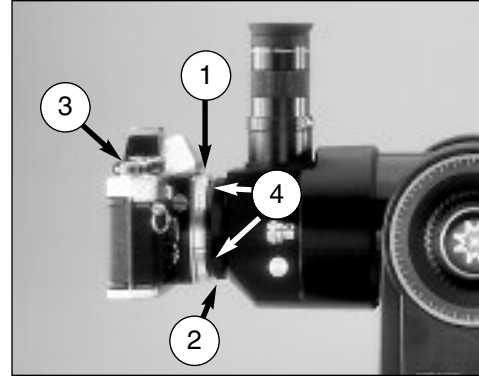

**Fig. 17:** ETX with #64ST T-Adapter.

#### A few tips on photography with the ETX-60AT or ETX-70AT:

1. Use the optional #882 Standard Field Tripod or the #883 Deluxe Field Tripod as a platform for the telescope. At an effective focal length of 350mm, even small external vibrations can easily ruin an otherwise good photo.

**CAUTION:** With the #64ST T-Adapter and a camera body mounted to the ETX-60AT or ETX-70AT photo port, the telescope can only be rotated vertically about 45°. Moving past this point may damage the telescope and camera.

2. Use a cable-operated shutter release. Touching the camera body to initiate shutter operation almost certainly introduces undesirable vibrations.
3. Focus the image with extreme care. While observing the subject through the camera's reflex viewfinder, turn the telescope's focus knob (8, Fig. 1) to achieve the sharpest possible focus. Note that some 35mm cameras may have an optional focusing screen (available from the manufacturer) for use with a long telephoto lens. This screen provides a brighter and clearer image to focus, and is highly recommended.
4. Correct shutter speeds vary widely, depending on lighting conditions and film used. Trial-and-error is the best way to determine proper shutter speed in any given application.

**NOTE:** The camera used with your telescope may have an exposure meter that is still active when the standard lens is removed and the body is connected to the telescope with the T-Mount. If used for terrestrial photography, the camera meter should be acceptable. If used for astrophotography, the meter probably will not provide good results since camera meters are not made to compensate for a dark sky.

5. Terrestrial photography through the ETX-60AT or ETX-70AT is sensitive to heat waves rising from the Earth's surface. Long distance photography is best accomplished in the early morning hours before the earth has had time to build up heat.
6. Photography of the Moon and planets through the ETX-60AT or ETX-70AT can be especially gratifying, but points 1 through 4 should be particularly noted in this case. Lunar or planetary photography requires that the telescope be Polar aligned. See "APPENDIX A," page 31.

**NOTE:** Long exposure photography of deep-sky objects is not practical with the ETX-60AT and ETX-70AT, since this type of photography requires special electronic and optical guiding devices not available for these telescopes.



## OPTIONAL ACCESSORIES

A wide assortment of professional Meade accessories are available for the ETX-60AT and ETX-70AT. Meade accessories greatly extend many important applications to the telescope, from low-power, wide-field terrestrial viewing to high-power lunar and planetary observing. The premium quality of these accessories is well-suited to the quality of the instrument itself.

Meade telescopes and accessories, including optional accessories for ETX telescopes, are available at more than 3,000 dealer locations in the U.S. and Canada and through Meade international distributors worldwide. Once you have identified the accessories you wish to order, contact your local Meade authorized dealer. To find a dealer near you call **(949) 451-1450** or visit the Meade website at **www.meade.com**.



**Fig. 18:** AstroFinder Software.

**#506 AstroFinder™ Software and Cable Connector Kit:** Displays more than 10,000 celestial wonders – galaxies, nebulae, star clusters, stars, and planets – on your PC, enabling even the beginner to locate and identify objects to observe with the telescope or to print out star charts for use in observing sessions. Operates with any Windows™-based personal computer. The Cable Connector Kit permits connection of the ETX-60AT and the ETX-70AT, Autostar, and PC, for downloading of new software to Autostar or for updating of Earth satellite or other celestial object positions. This kit is included with each AstroFinder Software package.

**Eyepieces:** Meade Modified Achromatic eyepieces, supplied as standard-equipment with the ETX-60AT and the ETX-70AT, permit observing powers of 39X (MA 9mm) and 14X (MA 25mm). Optional eyepieces of the Plössl (PL) optical design yield higher and lower powers, combined with bright, sharp images. Any of these eyepieces may be used in conjunction with the #124 2x Barlow Lens or #128 3x Barlow Lens (below) to double or triple, respectively, eyepiece powers.

Meade Modified Achromatic (MA) and Wide Angle (WA) eyepieces in the standard American-size (1.25") barrel diameter (**Fig. 19**) permit a wide range of magnifying powers with the ETX-60AT and ETX-70AT. Powers obtained with each available eyepiece are shown in the following table:



**Fig. 19:** Optional Eyepieces.

Eyepiece	Power	with Barlow lens	
		with #124 2x Barlow lens	with #128 3x Barlow lens
MA 9mm*	39X	78X	117X
MA 25mm*	14X	28X	42X
PL 4mm	88X	176X	264X
PL 5mm	70X	140X	210X
PL 6mm	58X	116X	174X
WA 18mm	19X	38X	57X

\* Included as standard-equipment with the ETX-60AT and ETX-70AT

Meade Modified Achromatic (MA), Wide Angle (WA), and Plössl (PL) eyepieces are ideal for general-purpose astronomical or terrestrial observing. The typical ETX-60AT or ETX-70AT user may wish to add two or three of these eyepieces to his or her telescope. An introductory selection might include the PL 6mm eyepiece, while the more advanced observer might select the PL 4mm, PL 5mm, and WA 18mm. The Meade Wide Angle 18mm eyepiece yields wide fields of view, perfect for the examination of star fields, diffuse nebulae, or for terrestrial applications.

**#124 2x Barlow Lens and #128 3x Barlow Lens:** For high-power astronomical applications these coated, amplifying lenses double (#124) or triple (#128) eyepiece magnifying powers without any reduction of image resolution. **Example:** By itself the PL 5mm eyepiece yields a power of 70X with the ETX-70AT; used with the #128 3x Barlow Lens, this eyepiece yields a power of 210X. Insert either Barlow Lens into the telescope's eyepiece holder, followed by an eyepiece.

These lenses are achromatic, high-performance, short-focus Barlow lenses, perfectly suited to the low-profile design of the ETX-60AT and ETX-70AT. Lens surfaces are coated for maximum image contrast and light transmission.



**Fig 20:** #773 Hard Carry Case.



**Fig 21:** #64ST T-Adapter.



**Fig 22:** #827 Right-Angle Viewfinder.



**Fig 23:** #933 Erecting Prism.



**Fig 24:** #670 Dew Shield.

**#3200 Lunar & Planetary Color Filter Set:** Meade optical glass color filters increase image contrast and resolution of the Moon and planets. The #3200 Set includes light yellow, very light red, very light blue, and neutral density filters. Each filter threads into the barrels of all Meade MA, PL, and WA eyepieces and is packed in a separate plastic case for secure storage.

**#773 Hard Carry Case:** For secure portability in the field, the #773 Hard Carry Case (**Fig. 20**) is fully lined with fitted foam inserts and accepts the complete ETX-60AT or ETX-70AT Astro Telescope, plus optional accessories. In order for the telescope to fit in its optional Hard Carry Case, the telescope's objective lens must be fully retracted.

**#64ST T-Adapter:** The #64ST T-Adapter (**Fig. 21**) is the basic means of photography through the ETX-60AT or the ETX-70AT. Attach the #64ST T-Adapter to the rear cell of the telescope, followed by a T-Mount appropriate to your 35mm camera body, and the ETX-60AT or ETX-70AT is a supertelephoto lens of 350mm focal length. See "PHOTOGRAPHY WITH THE ETX," page 23.

**#827 8 x 25mm Right-Angle Viewfinder and Bracket:** For easy sighting of terrestrial or astronomical objects prior to their observation in the main telescope, the #827 8 x 25mm Right-Angle Viewfinder (**Fig. 22**) displays a wide 7.5° field of view. Includes a crosshair eyepiece and precise helicoid focusing; the included viewfinder bracket attaches to the main telescope in seconds.

**#933 45° Erecting Prism:** The ETX-60AT or ETX-70AT includes an internal optically-flat mirror to reflect light to the telescope's 90° astronomical observing position. In this position, the telescope's image is upright, but reversed left for right. For terrestrial observing with the ETX-60AT or ETX-70AT, the #933 45° Erecting Prism (**Fig. 23**) results in a fully correctly oriented image and a convenient 45° observing angle. The #933 Prism threads on to the telescope's photo port (**16, Fig. 1**). An eyepiece of any focal length (magnifying power) may be inserted into the #933 Prism. The #933 includes an internal relay lens which increases each eyepiece power by 2.4x. Note that the flip-mirror control (**15, Fig. 1**) must be in the "down" position (**Fig. 2b**) for use with the #933 Prism.

**IMPORTANT NOTE:** In the most discriminating applications, such as in observing delicate bird feather structure at long distance, the telescope's internal, optically-flat mirror yields a higher-resolution image than is possible with any prism, including the #933. In these special cases, users are advised to observe with the eyepiece in the standard 90° eyepiece-holder (**15, Fig. 1**), with the flip-mirror control in the "up" position (**Fig. 2a**). This admonition applies only to situations requiring extraordinarily high optical resolution where the observer's eye is well-trained to observe very fine detail. In typical terrestrial applications, no image differences between the two eyepiece locations can generally be noted.

**#670 Dew Shield:** In moist climates, water in the atmosphere may condense on the telescope's lens. Dew formation may be reduced significantly by the addition of a #670 Dew Shield (**Fig. 24**), which threads into the front cell of the telescope.



**Fig. 25a:** #882 Standard Field Tripod set in Alt/Az Configuration.



**Fig 25b:** #883 Deluxe Field Tripod set in Polar Configuration.

**Tripods:** Manufactured of strong, lightweight extruded aluminum, the **#882 Standard Field Tripod** (**Fig. 25a**) and the **#883 Deluxe Field Tripod** (**Fig. 25b**) allow standing or seated observations. The heights of both tripods are continuously adjustable from 34" to 54". Micrometric controls in both azimuth and elevation-angle of the #883 Deluxe Field Tripod permit precise Polar Alignment of the telescope's fork mount for advanced astronomical applications. When Alt/Az Alignment of the telescope is desirable, the tripod head of the #883 tilts and locks at 90°. Both tripods include all the rigidity and stability required for high-power observing through the telescope.

# MAINTENANCE AND SERVICING

## General Maintenance

The ETX-60AT and ETX-70AT telescopes are precision optical instruments designed to yield a lifetime of rewarding applications. Given the care and respect due any precision instrument, your telescope will rarely require factory servicing or maintenance. Maintenance guidelines include:

1. Avoid cleaning the telescope's optics. A little dust on the front surface of the telescope's correcting lens causes virtually no degradation of image quality and should not be considered reason to clean the lens.
2. When absolutely necessary, dust on the front lens should be removed with gentle strokes of a camel hair brush or blown off with an ear syringe (available at any pharmacy). Do not use a commercial photographic lens cleaner.
3. Organic materials (e.g., fingerprints) on the front lens may be removed with a solution of 3 parts distilled water to 1 part isopropyl alcohol. A single drop of biodegradable dish-washing soap may be added per pint of solution. Use soft, white facial tissues and make short, gentle strokes. Change tissues often.

**CAUTION:** Do not use scented, colored, or lotioned tissues as damage could result to the optics.

4. If your telescope is used outdoors on a humid night, telescope surfaces may accumulate water condensation. While such condensation does not normally cause any damage to the telescope, it is recommended that the entire telescope be wiped down with a dry cloth before being packed away. Do not, however, wipe any of the optical surfaces. Rather, simply allow the telescope to sit for some time in warm indoor air, so that the wet optical surfaces can dry unattended. In addition, the dust cap should not be placed back on to the optical tube until the telescope is thoroughly dry.
5. If your telescope is not to be used for an extended period, perhaps for one month or more, it is advisable to remove the six AA-size batteries from inside the drive base. Batteries left installed for prolonged periods may leak, causing damage to the telescope's electronic circuitry. See "HOW TO ASSEMBLE YOUR TELESCOPE," page 10.
6. Do not leave your telescope outdoors on a warm day or inside a sealed car for an extended period of time. Excessive ambient temperatures can damage the telescope's internal lubrication and electronic circuitry.
7. A (English-format) hex wrench is provided with the ETX-60AT or ETX-70AT. Use the wrench to tighten the set-screws of any knobs which may loosen, such as the horizontal lock knob or focus knob.

## Storage and Transport

When not in use, store the telescope in a cool, dry place. Do not expose the instrument to excessive heat or moisture. It is best to store the telescope in its original box with the vertical and horizontal locks (**6 and 9, Fig. 1**) in the unlocked positions. If shipping the telescope, use the original box and packing material to protect the telescope during shipment.

When transporting the telescope, take care not to bump or drop the instrument; this type of abuse can damage the optical tube and/or the objective lens. It is highly recommended to use the optional Hard Case to transport the telescope. See "OPTIONAL ACCESSORIES," page 25.

## Inspecting the Optics

**A Note About the "Flashlight Test":** If a flashlight or other high-intensity light source is pointed down the main telescope tube, the view (depending upon the observer's line of sight and the angle of the light) may reveal what appears to be scratches, dark or bright spots, or uneven coatings, giving the appearance of poor quality optics. These effects are only seen when a high intensity light is transmitted through the lens or reflected off the mirror, and can be seen on any high quality optical system, including giant research telescopes.

The optical quality of a telescope cannot be judged by the "flashlight test"; the true test of optical quality can only be conducted through careful star testing.

## Troubleshooting

The following suggestions may be helpful with operation of the ETX-60AT or ETX-70AT.

### ***The power indicator light on the telescope does not come on or there is no response when pressing Autostar Arrow keys:***

- Verify that the Computer Control Panel power switch (**10C, Fig. 1**) is in the ON position.
- Verify that the Autostar cord (**4, Fig. 3**) is firmly connected to the HBX port (**10A, Fig. 1**).
- Verify that the batteries are installed correctly and that they have sufficient charge. See “HOW TO ASSEMBLE YOUR TELESCOPE,” page 10.

**NOTE:** *If the batteries are getting low on charge, there will be a marked difference in the slew speed. The speed indicator lights may also flash and the speed may change. If any of these symptoms occur, turn the power off and replace the batteries.*

- If Autostar does not respond to commands, set the Computer Control Panel power switch to OFF and then back to ON.
- If the telescope does not slew after power is applied or if the motor quits or stalls, verify that there are no physical obstructions that would impede telescope movement.
- If all physical obstacles are removed and the telescope still does not move properly, turn off the power and unplug Autostar. Plug the Autostar back in and turn the power back on.

### ***Unable to see an image through the eyepiece:***

- Confirm that the dust cap has been removed from the telescope.
- Confirm that the flip-mirror control (**15, Fig. 1**) is in the “up” position (**Fig. 2a**) if using the eyepiece holder (**3, Fig. 1**) so that light is directed to the eyepiece (**1, Fig. 1**). Confirm that the flip-mirror control is in the “down” position (**Fig. 2b**) if using the #933 Erecting Prism or performing photography with the ETX-60AT or ETX-70AT. See “TELESCOPE FEATURES,” page 4 and “PHOTOGRAPHY WITH THE ETX,” page 23.

### ***Slew speed does not change when the Speed/? key is pressed, or the telescope moves slowly even though the fast slew speed is chosen:***

- The battery power may be low. See “HOW TO ASSEMBLE YOUR TELESCOPE,” page 10.

### ***Images through the eyepiece appear unfocused or distorted:***

- The magnification used may be too high for the seeing conditions. Back off to a lower power eyepiece. See “TOO MUCH POWER?,” page 11.
- If inside a warm house or building, move outside. Interior air conditions may distort terrestrial or celestial images, making it difficult, if not impossible, to obtain a sharp focus. For optimal viewing, use the telescope outside in the open air instead of observing through an open or closed window or screen.
- If viewing a land object on a warm day, heat waves distort the image. See “TERRESTRIAL OBSERVING,” page 21.
- For clear viewing of objects, turn the focus knob (**8, Fig. 1**) slowly since the “in-focus” point of a telescope is precise. Turning the focus knob too quickly may cause the focus point to pass without notice.
- The optics within the telescope need time to adjust to the outside ambient temperature to provide the sharpest image. To “cool down” the optics, set the telescope outside for 10 to 15 minutes before observing begins.

### ***When turning the focus knob, it takes a moment for the image to change:***

- The focus knob may need to be reset. Verify that the dust cover is in place at the front of the objective lens cell (**5, Fig. 1**). Turn the optical tube so that is pointing straight up through the fork arms and lock the vertical lock. Carefully, turn the telescope upside down so that the front of the objective lens cell is resting on a clean, flat surface. Use the provided hex wrench to slightly loosen the focus knob set screw. Make sure the focus knob is flush against the rear cell of the telescope and retighten the focus knob set screw.

**Telescope moves off a terrestrial object while observing:**

- Verify that the vertical and horizontal locks have been tightened to a "firm feel" (6 and 9 Fig. 1).

**Telescope pauses when changing slew direction:**

- This pause is normal.

**A terrestrial object appears reversed left-for-right:**

- An eyepiece in the standard 90° observing position (3, Fig. 1) yields this image orientation. To view a correctly oriented image, the optional #933 Erecting Prism is required. See "OPTIONAL ACCESSORIES," page 25.

## Meade Customer Service

If you have a question concerning your ETX-60AT or ETX-70AT, contact the Meade Instruments Customer Service Department at:

**Telephone:** (949) 451-1450

Customer Service hours are 8:30 AM to 4:30 PM, Pacific Time, Monday through Friday. In the unlikely event that the ETX requires factory servicing or repairs, write or call the Meade Customer Service Department first, before returning the telescope to the factory, giving full particulars as to the nature of the problem, as well as your name, address, and daytime telephone number. The great majority of servicing issues can be resolved by telephone, avoiding return of the telescope to the factory.

## ETX-60AT/ETX-70AT Specifications

Optical design .....	Achromatic Refractor
Clear aperture	
ETX-60AT .....	60mm (2.36")
ETX-70AT .....	70mm (2.76")
Focal length.....	350mm
Focal ratio (photographic speed)	
ETX-60AT .....	f/5.8
ETX-70AT .....	f/5
Near focus (approx.)	
ETX-60AT .....	15 ft. (4.6m)
ETX-70AT .....	17 ft. (5.2m)
Resolving power	
ETX-60AT .....	1.9 arc secs
ETX-70AT .....	1.6 arc secs
Multi-coatings on objective lens .....	Standard
Limiting visual stellar magnitude (approx.)	
ETX-60AT .....	11.2
ETX-70AT .....	11.5
Image scale	
ETX-60AT .....	4.1°/inch
ETX-70AT .....	4.1°/inch
Maximum practical visual power	
ETX-60AT .....	200X
ETX-70AT .....	240X
Optical tube dimensions	
(dia. x length).....	9.3cm x 30.4-37.1cm (3.6" x 12-14.6")
Eyepieces	
Modified Achromatic .....	MA 25mm (1.25" O.D.)
Modified Achromatic .....	MA 9mm (1.25" O.D.)
Telescope mounting.....	Fork type; double tine
Setting circle diameters .....	Dec: 3.5"; RA: 7"
Input voltage .....	9-volts DC
Motor Drive System .....	DC servo motors with encoders, both axes

## ETX-60AT/ETX-70AT Specifications (cont'd)

Slow-Motion Controls .....	Electric, 9 speed, both axes
Hemispheres of operation .....	North and South, switchable
Bearings:	
Altitude .....	Acetal
Azimuth .....	Nylon
Materials	
Tube body .....	ABS
Mounting .....	High-impact ABS
Objective lens (crown, flint) .....	BK7, F2
Telescope dimensions .....	40.4cm x 18cm x 22cm (15.9" x 7" x 9")
Telescope net weight: (telescope only, without batteries, eyepieces)	
ETX-60AT .....	2.6 kg (5.8 lbs.)
ETX-70AT .....	2.7 kg (5.9 lbs.)
Telescope shipping weight (telescope, accessories, instruction manual and packing)	
ETX-60AT .....	5.4 kg (11.9 lbs.)
ETX-70AT .....	5.3 kg (11.7 lbs.)
Battery Life (approx.)	
with Autostar .....	20 hrs.

## Autostar Specifications

Processor .....	68HC11, 8MHz
Flash Memory .....	.512KB, reloadable
Keypad.....	10 key alphanumeric
Display .....	.2 line, 16 character LCD
Backlight .....	Red LED
Coil Cord .....	24"

## Autostar Dimensions

Length .....	14.2cm (5.60")
Width (LCD end) .....	78.0cm (3.08")
Width (Connector end) .....	53.5cm (2.10")
Depth .....	23.5cm (0.93")
Autostar net weight .....	0.169kg (0.35 lbs.)

# APPENDIX A: EQUATORIAL (POLAR) ALIGNMENT

## Polar Alignment

The great majority of ETX-60AT and ETX-70AT owners will find it unnecessary ever to Polar align the telescope. With these ETX telescope models the standard-equipment Autostar controller allows the telescope to be used in the altazimuth (Alt/Az) orientation for all observing purpose. This section is included only for educational purposes, where the observer might wish to operate the analog setting circles (**13 and 17, Fig.1**) in place of the digital setting circles built into the Autostar hand controller. Absent a desire to use the analog circles or simply to be informed about the use of the equatorial (Polar-aligned) mount, reading of this appendix may be omitted.



**Fig. 26:** Tripod set in Polar configuration on optional #883 tripod.

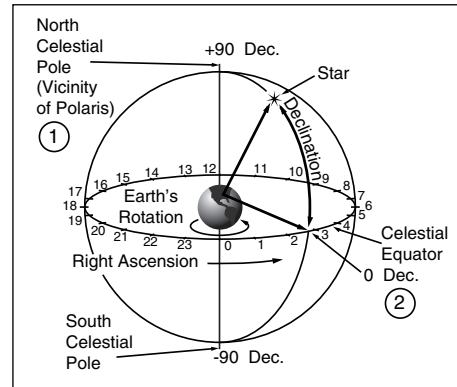

**Fig. 27:** Celestial Sphere.

In Polar Alignment, the telescope is oriented so that the horizontal and vertical axes of the telescope are lined up with the celestial coordinate system. Polar Alignment requires the telescope to be mounted to the optional #883 Deluxe Field Tripod (**Fig. 26**).

In order to Polar align your telescope, it is essential to have an understanding of how and where to locate celestial objects as they move across the sky. This section provides a basic introduction to the terminology of Polar-aligned astronomy, and includes instructions for finding the celestial pole and for finding objects in the night sky using Declination and Right Ascension.

## Celestial Coordinates

Celestial objects are mapped according to a coordinate system on the Celestial Sphere (**Fig. 26**), an imaginary sphere surrounding Earth on which all stars appear to be placed. This celestial object mapping system is analogous to the Earth-based coordinate system of latitude and longitude.

The poles of the celestial coordinate system are defined as those two points where the Earth's rotational axis, if extended to infinity, North and South, intersect the celestial sphere. Thus, the North Celestial Pole (**1, Fig. 27**) is that point in the sky where an extension of the Earth's axis through the North Pole intersects the celestial sphere. This point in the sky is located near the North Star, Polaris.

In mapping the surface of the Earth, lines of longitude are drawn between the North and South Poles. Similarly, lines of latitude are drawn in an East-West direction, parallel to the Earth's Equator. The Celestial Equator (**2, Fig. 27**) is a projection of the Earth's Equator onto the celestial sphere.

Just as on the surface of the Earth, in mapping the celestial sphere, imaginary lines have been drawn to form a coordinate grid. Thus, object positions on the Earth's surface are specified by their latitude and longitude. For example, you could locate Los Angeles, California, by its latitude (+34°) and longitude (118° West); similarly, you could locate the constellation Ursa Major (which includes the Big Dipper) by its general position on the celestial sphere:

R.A.: 11hr; Dec: +50°.

- **Right Ascension:** The celestial analog to Earth longitude is called "Right Ascension," or "R.A.," and is measured in time on the 24 hour "clock" and shown in hours or "hr," minutes or "min," and seconds or "sec," from an arbitrarily defined "zero" line of Right Ascension passing through the constellation Pegasus. Right Ascension coordinates range from 0hr 0min 0sec to 23hr 59min 59sec. Thus there are 24 primary lines of R.A., located at 15 degree intervals along the celestial equator. Objects located further and further East of the prime Right Ascension grid line, 0hr 0min 0sec, carry increasing R.A. coordinates.
- **Declination:** The celestial analog to Earth latitude is called Declination, or "Dec," and is measured in degrees, arc-minutes and arc-seconds, e.g., 15° 27' 33". Declination shown as North of the celestial equator is indicated with a "+" sign in front of the measurement,

e.g., the Declination of the North Celestial Pole is  $+90^\circ$ , with Declination South of the celestial equator indicated with a “-” sign, e.g., the Declination of the South Celestial Pole is  $-90^\circ$ . Any point on the celestial equator itself which, for example, passes through the constellations Orion, Virgo, and Aquarius, is specified as having a Declination of zero, shown as  $0^\circ 0' 0''$ .

All celestial objects are specified in position by their celestial coordinates of Right Ascension and Declination.

**NOTE:** Since the second object (i.e., the object to be located) is in constant motion, once the R.A. circle is calibrated (step 2 above), the telescope should be moved rapidly to read the coordinates of the second object. Otherwise the second object will no longer be in the position indicated by the R.A. circle.

**IMPORTANT**

**NOTE:** In order to select any of Autostar's three Polar Alignment options, you must first select "Polar" in the "Mount" option of the "Setup: Telescope" menu.

Using setting circles requires a developed technique. When using the circles for the first time, try hopping from one bright star (the calibration star) to another bright star of known coordinates. Practice moving the telescope from one easy-to-find object to another. In this way, the precision required for accurate object location becomes evident.

**NOTE:** You may also enter an object's R.A. and Dec coordinates using the "User: Objects" option of Autostar's Object menu. Autostar then automatically slews the telescope to the entered coordinates.

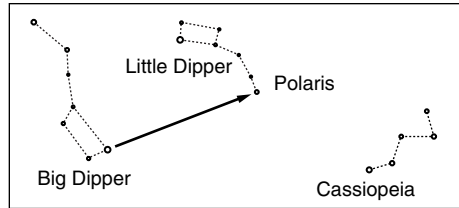

**Fig. 28:** Locating Polaris.

**Locating the Celestial Pole**

To get basic bearings at an observing location, take note of where the Sun rises (East) and sets (West) each day. After the site is dark, face North by pointing your left shoulder toward where the Sun set. To precisely point at the pole, find the North Star (Polaris) by using the Big Dipper as a guide (**Fig. 28**).

For precise tracking of astronomical objects, your telescope should be Polar aligned.

To Polar Align using the #883 Deluxe Field Tripod, follow the instructions provided with the tripod.

**IMPORTANT NOTE:** For almost all astronomical observing requirements, approximate settings of the telescope's latitude and Polar axis are acceptable. Do not allow undue attention to precise Polar Alignment of the telescope to interfere with your basic enjoyment of the instrument. In those unusual cases where more precise.

**NOTE:** When the telescope is Polar aligned, the Vertical Lock (6, **Fig. 1**) serves as a Declination Lock and the Horizontal Lock serves as a Right Ascension, or R.A. Lock (9, **Fig. 1**).

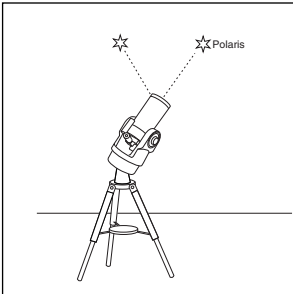

**Fig. 29:** Polar One-Star Alignment.

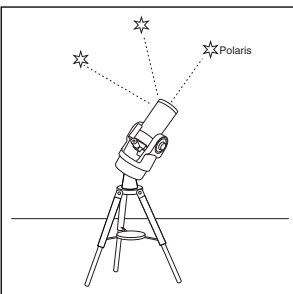

**Fig. 30:** Polar Easy and Two-Star Alignment.

**Autostar Polar Alignment**

Autostar provides three different methods for Polar Alignment: Easy, One-Star and Two-Star. In each method, the telescope is pointed at Polaris, which Autostar uses the star as a reference.

**Easy Polar Alignment**

**Level:** Intermediate to Advanced

Polaris and two alignment stars are chosen by Autostar based on the date, time, and location entered. The rest of the procedure is identical to the Easy Two-Star Alt/Az: Alignment (**Fig. 30**).

**One-Star Polar Alignment**

**Level:** Advanced

Polar Two-Star Alignment requires some knowledge of the night sky. Autostar provides a database of bright stars and one star from this database is chosen by the observer for alignment. Polaris is chosen by Autostar. The rest of the alignment procedure is identical to the Easy Two-Star Alt/Az: Alignment (**Fig. 29**). See "EASY TWO-STAR ALIGNMENT," page 14.

**Two-Star Polar Alignment**

**Level:** Advanced

Polar Two-Star Alignment requires some knowledge of the night sky. Autostar provides a database of bright stars and two stars from this database are chosen by the observer for alignment. Polaris is chosen by Autostar. The rest of the alignment procedure is identical to the Easy Two-Star Alt/Az: Alignment (**Fig. 30**). See "EASY TWO-STAR ALIGNMENT," page 14.



## APPENDIX B: USING AUTOSTAR TO ENTER R.A. AND DEC COORDINATES

Although Autostar's database contains more than 1400 objects (stars, nebulae, planets, etc.) that you can observe, you may eventually want to view objects that are not part of the database. Autostar provides a feature that allows you to enter an object's R.A and Dec coordinates in the "User: Objects" option of Autostar's Object menu and then automatically slews the telescope to the user-entered coordinates.

In order to use this menu option, you first need to look up the R.A and Dec coordinates of the object or objects you wish to observe. Check out your local library, computer store or bookstore for astronomy books, CD Roms, or magazines (such as *Sky & Telescope* or *Astronomy*), to find coordinates of celestial objects. A list of the coordinates of 14 common stars are printed at the end of this manual; see "STAR LOCATOR," page 39.

The objects/coordinates you enter become part of your own permanent database, called "User Objects." You may use this menu to view these object as often as you like, but the objects' coordinates just need to be entered once.

### To enter coordinates of an object into the "User: Objects" option of the Object menu:

1. Make sure Autostar has been initialized (see "INITIALIZING AUTOSTAR," page 12) and the telescope has been aligned and set to the Alt/Az home alignment position (see "EASY TWO-STAR ALIGNMENT," page 14).
2. After the telescope is aligned, "Select Item: Object" displays. (If necessary, use the Scroll keys to scroll through the menus, as previously described, to find this option.) Press ENTER.
3. "Object: Solar System" displays. Keep pressing the Scroll Up key until "Object: User Object" displays and press ENTER.
4. "User Object: Select" displays. Press the Scroll Down key once. "User Object: Add" displays. Press ENTER.
5. "Name" displays on the top line and a blinking cursor on the second line. Use the Arrow keys (as previously described) to enter the name of the object you wish to add to the database. When you are finished, press ENTER.
6. "Right Asc.: +00.00.0" displays. Use the Arrow keys to enter the digits for the Right Ascension coordinate of your object. If necessary, use the Scroll Keys to change "+" to "-." When you are finished, press ENTER.
7. "Declination: +00° .00'" displays. Use the Arrow keys to enter the digits for the Declination coordinate of your object. If necessary, use the Scroll Keys to change "+" to "-." When you are finished, press ENTER.
8. Autostar then prompts you to enter the Size of the object. This step is optional. Use the Arrow keys to enter this information, if so desired, and press ENTER to go to the next display. If you do not wish to enter this information, simply press ENTER.
9. Autostar then prompts you to enter the Magnitude of the object. This step is also optional. Use the Arrow keys to enter this information, if so desired, and press ENTER to go to the next display. "User Object: Add" displays again.

### To GO TO a user-entered object:

1. With "User Object: Add" displayed, press the Scroll Up key once. "User Object: Select" displays. Press ENTER.
2. Use the Scroll keys (if necessary) to scroll to the desired object. Press ENTER.
3. The name of the object and the Right Ascension and Declination coordinates display.
4. Press GO TO and the telescope slews to the object.

# APPENDIX C: HELPFUL CHARTS

## Latitude Chart for Major Cities of the World

To aid in the Polar Alignment procedure (see page 30), latitudes of major cities around the world are listed below. To determine the latitude of an observing site not listed on the chart, locate the city closest to your site. Then follow the procedure below:

**Northern Hemisphere observers (N):** If the site is over 70 miles (110 km) North of the listed city, add one degree for every 70 miles. If the site is over 70 miles South of the listed city, subtract one degree per 70 miles.

**Southern Hemisphere observers (S):** If the site is over 70 miles North of the listed city, subtract one degree for every 70 miles. If the site is over 70 miles South of the listed city, add one degree per 70 miles.

UNITED STATES			SOUTH AMERICA		
City	State	Latitude	City	Country	Latitude
Albuquerque	New Mexico	35° N	Asuncion	Paraguay	25° S
Anchorage	Alaska	61° N	Brasilia	Brazil	24° S
Atlanta	Georgia	34° N	Buenos Aires	Argentina	35° S
Boston	Massachusetts	42° N	Montevideo	Uruguay	35° S
Chicago	Illinois	42° N	Santiago	Chile	34° S
Cleveland	Ohio	41° N	<hr/>		
Dallas	Texas	33° N	ASIA		
Denver	Colorado	40° N	City	Country	Latitude
Detroit	Michigan	42° N	Beijing	China	40° N
Honolulu	Hawaii	21° N	Seoul	South Korea	37° N
Jackson	Mississippi	32° N	Taipei	Taiwan	25° N
Kansas City	Missouri	39° N	Tokyo	Japan	36° N
Las Vegas	Nevada	36° N	Victoria	Hong Kong	23° N
Little Rock	Arkansas	35° N	<hr/>		
Los Angeles	California	34° N	AFRICA		
Miami	Florida	26° N	City	Country	Latitude
Milwaukee	Wisconsin	46° N	Cairo	Egypt	30° N
Nashville	Tennessee	36° N	Cape Town	South Africa	34° S
New Orleans	Louisiana	30° N	Rabat	Morocco	34° N
New York	New York	41° N	Tunis	Tunisia	37° N
Oklahoma City	Oklahoma	35° N	Windhoek	Namibia	23° S
Philadelphia	Pennsylvania	40° N	<hr/>		
Phoenix	Arizona	33° N	AUSTRALIA		
Portland	Oregon	46° N	City	State	Latitude
Richmond	Virginia	37° N	Adelaide	South Australia	35° S
Salt Lake City	Utah	41° N	Brisbane	Queensland	27° S
San Antonio	Texas	29° N	Canberra	New South Wales	35° S
San Diego	California	33° N	Alice Springs	Northern Territory	24° S
San Francisco	California	38° N	Hobart	Tasmania	43° S
Seattle	Washington	47° N	Perth	Western Australia	32° S
Washington	District of Columbia	39° N	Sydney	New South Wales	34° S
Wichita	Kansas	38° N	Melbourne	Victoria	38° S
<hr/>			<hr/>		
EUROPE					
City	Country	Latitude			
Amsterdam	Netherlands	52° N			
Athens	Greece	38° N			
Bern	Switzerland	47° N			
Copenhagen	Denmark	56° N			
Dublin	Ireland	53° N			
Frankfurt	Germany	50° N			
Glasgow	Scotland	56° N			
Helsinki	Finland	60° N			
Lisbon	Portugal	39° N			
London	England	51° N			
Madrid	Spain	40° N			
Oslo	Norway	60° N			
Paris	France	49° N			
Rome	Italy	42° N			
Stockholm	Sweden	59° N			
Vienna	Austria	48° N			
Warsaw	Poland	52° N			

# APPENDIX D: TRAINING THE DRIVE

Train the telescope motors using Autostar. Perform this procedure after RESET or if you are experiencing any pointing accuracy problems. Figure 30 depicts the complete Drive Training procedure.

**NOTE:** Use a terrestrial object, such as a telephone pole or lamp post, to train the drive. Complete this exercise once every 3 to 6 months to maintain the highest level of telescope pointing accuracy.

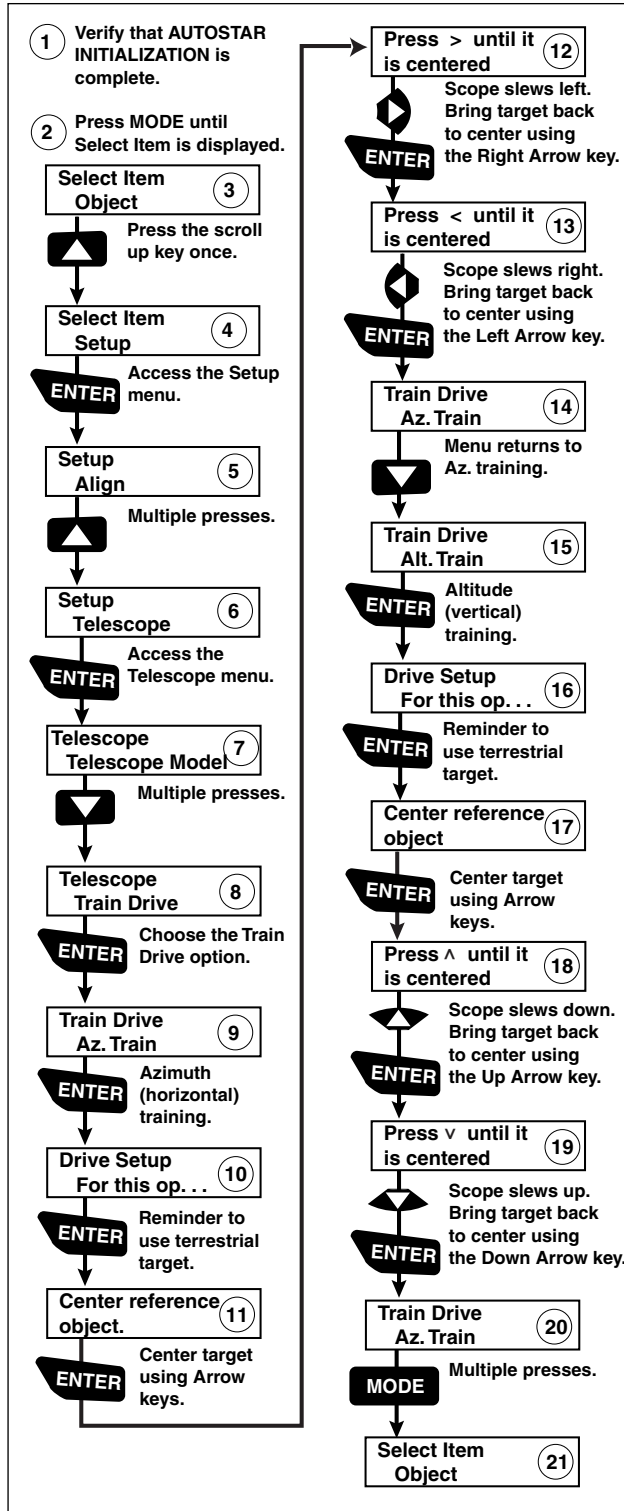

Figure 30: Training the Drive Procedure.

TIPS FOR BEGINNERS

### Further Study...

This manual gives only the briefest introduction to astronomy. If you are interested in pursuing further studies in astronomy, a few topics are suggested below that are worth reading up on. Try looking up some of these topics in Autostar's glossary.

Also included below is a small sampling of books, magazines, and organizations that you might find helpful.

#### Topics

1. How is a star born? How does a solar system form?
2. How is the distance to a star measured? What is a light year?
3. What is red shift and blue shift?
4. How are the craters on our Moon formed? How old is the Moon and Earth? How old is the Sun?
5. What is a black hole? A quasar? A neutron star?
6. What are stars made of? Why are stars different colors? What is a white dwarf? A red giant?
7. What is a nova? A supernova?
8. What are comets? Asteroids? Meteors? Meteor showers? Where do they come from?
9. What is a planetary nebula? A globular cluster?
10. What is the Big Bang? Is the universe expanding or contracting, or does it always remain the same?

#### Books

1. The Guide to Amateur Astronomy by Jack Newton and Philip Teece
2. The Sky: A User's Guide by David Levy
3. Turn Left at Orion by Guy Consolmagno & Dan Davis
4. Astrophotography for the Amateur by Michael Covington

#### Magazines

1. Sky & Telescope  
Box 9111, Belmont, MA 02178
2. Astronomy  
Box 1612, Waukesha, WI 53187

#### Organizations:

1. Astronomical League  
Executive Secretary  
5675 Real del Norte, Las Cruces, NM 88012
2. The Astronomical Society of the Pacific  
390 Ashton Ave, San Francisco, CA 94112
3. The Planetary Society  
65 North Catalina Ave, Pasadena, CA 91106

## APPENDIX E: INITIALIZATION EXAMPLE

Initialization is a procedure that ensures that Autostar operates correctly. When you first use Autostar, it doesn't yet know where the observation location site is or the time or date of the observation session.

During the procedure, information, such as the current time and date, observation location, and telescope model, is entered into Autostar. Autostar uses this information to precisely calculate the location of celestial objects (such as stars and planets) and how to move your telescope correctly for various operations.

The diagram below depicts an example of the Autostar initialization procedure. The following are the parameters that are used in the example:

Date: March 26, 2001  
 Time: 12:47 AM  
 Location: Irvine, California

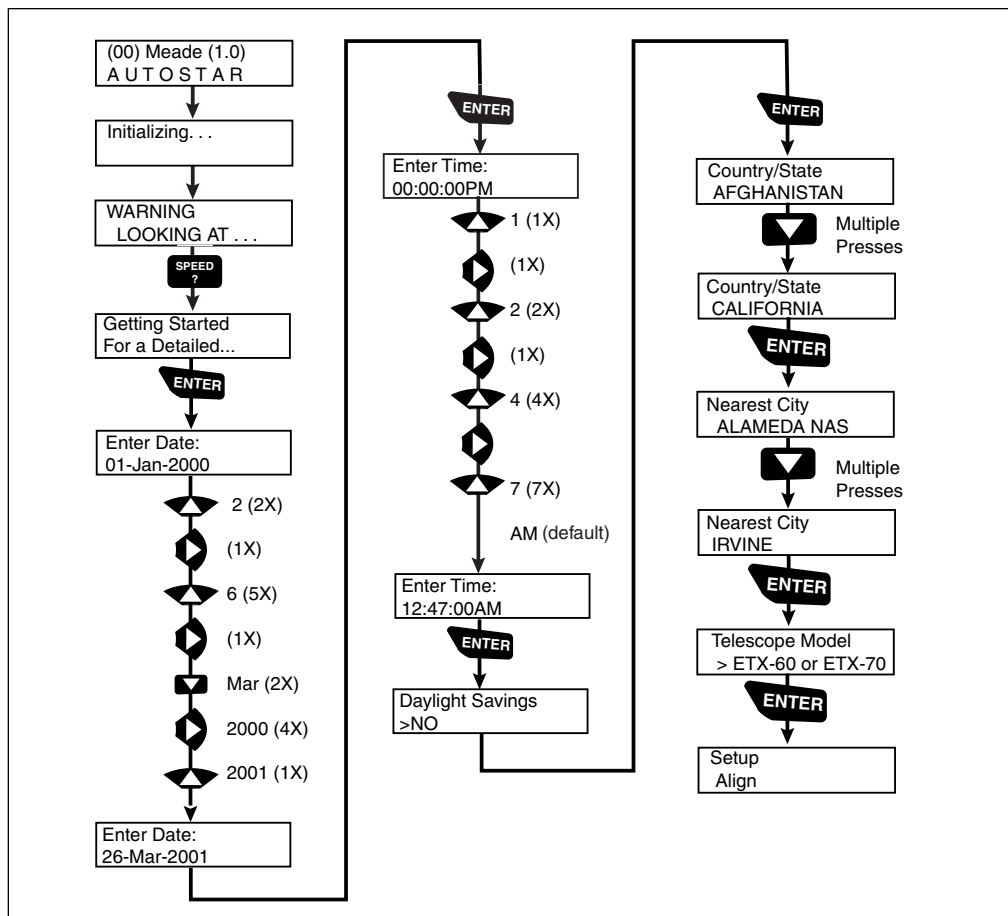

**Fig. 31:** Example of the Initialization Procedure.

## BASIC ASTRONOMY

In the early 17th century, Italian Scientist Galileo, using a crude telescope considerably smaller than the ETX-60AT or ETX-70AT, turned it to look towards the sky instead of distant trees and mountains. What he saw, and what he realized about what he saw, forever changed the way mankind thought of the universe. Imagine what it must have been like being the first human to see moons revolve around the planet Jupiter or to see the changing phases of Venus! Because of his observations, Galileo correctly realized Earth's movement and position around the Sun, and in doing so, gave birth to modern astronomy. Yet Galileo's telescope was so crude, he could not clearly make out the rings of Saturn.

Galileo's discoveries laid the foundation for understanding the motion and nature of the planets, stars, and galaxies. Building on his foundation, Henrietta Leavitt determined how to measure the distance to stars; Edwin Hubble proposed a glimpse into the origin of the universe; Albert Einstein unraveled the relationship of time and light. Almost daily, using sophisticated successors to Galileo's crude telescope, such as the Hubble Space Telescope, more and more mysteries of the universe are being solved and understood. We are living in a golden age of astronomy.

Unlike other sciences, astronomy welcomes contributions from amateurs. Much of the knowledge we have on subjects such as comets, meteor showers, variable stars, the Moon, and our solar system comes from observations made by amateur astronomers. So as you look through your Meade ETX telescope, keep in mind Galileo. To him, a telescope was not a mere machine of glass and metal, but something far more - a window through which the beating heart of the universe might be glimpsed, a fuse to set fire to mind and imagination.

### Autostar Glossary

Be sure to make use of Autostar's Glossary feature. The Glossary menu provides an alphabetical listing of definitions and descriptions of common astronomical terms. Access directly through the Glossary menu or through hypertext words embedded in Autostar. See "GLOSSARY MENU," page 18, for more information.

### Objects in Space

Listed below are some of the many astronomical objects that can be seen with the ETX-60AT or ETX-70AT:

#### The Moon

The Moon is, on average, a distance of 239,000 miles (380,000km) from Earth and is best observed during its crescent or half phase when Sunlight strikes the Moon's surface at an angle. It casts shadows and adds a sense of depth to the view (**Fig. 31**). No shadows are seen during a full Moon, causing the overly bright Moon to appear flat and rather uninteresting through the telescope. Be sure to use a neutral Moon filter when observing the Moon. Not only does it protect your eyes from the bright glare of the Moon, but it also helps enhance contrast, providing a more dramatic image.

Using the ETX-60AT or ETX-70AT, brilliant detail can be observed on the Moon, including hundreds of lunar craters and maria, described below.

**Craters** are round meteor impact sites covering most of the Moon's surface. With no atmosphere on the Moon, no weather conditions exist, so the only erosive force is meteor strikes. Under these conditions, lunar craters can last for millions of years.

**Maria** (plural for mare) are smooth, dark areas scattered across the lunar surface. These dark areas are large ancient impact basins that were filled with lava from the interior of the Moon by the depth and force of a meteor or comet impact.

Twelve Apollo astronauts left their bootprints on the Moon in the late 1960's and early 1970's. However, no telescope on Earth is able to see these footprints or any other artifacts. In fact, the smallest lunar features that may be seen with the largest telescope on Earth are about one-half mile across.



**Fig. 32:** The Moon.  
Note the deep shadows in the craters.

## Planets

Planets change positions in the sky as they orbit around the Sun. To locate the planets on a given day or month, consult a monthly astronomy magazine, such as *Sky and Telescope* or *Astronomy*. Listed below are the best planets for viewing through the ETX-60AT and ETX-70AT.



**Fig. 33:** Jupiter and its four largest moons. The moons can be observed in a different position every night.

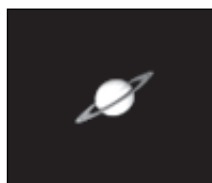

**Fig. 34:** Saturn has the most extensive ring structure in our Solar System.



**Fig. 35:** The Pleiades is one of the most beautiful open clusters.

**Venus** is about nine-tenths the diameter of Earth. As Venus orbits the Sun, observers can see it go through phases (crescent, half, and full) much like those of the Moon. The disk of Venus appears white as sunlight is reflected off the thick cloud cover that completely obscures any surface detail.

**Mars** is about half the diameter of Earth, and appears through the telescope as a tiny reddish-orange disk. It may be possible to see a hint of white at one of the planet's Polar ice caps. Approximately every two years, when Mars is closest to Earth in its orbit, additional detail and coloring on the planet's surface may be visible.

**Jupiter** is the largest planet in our solar system and is 11 times the diameter of Earth. The planet appears as a disk with dark lines stretching across the surface. These lines are cloud bands in the atmosphere. Four of Jupiter's 16 moons (Io, Europa, Ganymede, and Callisto) can be seen as "star-like" points of light when using even the lowest magnification (**Fig. 33**). These moons orbit Jupiter so that the number of moons visible on any given night changes as they circle around the giant planet.

**Saturn** is nine times the diameter of Earth and appears as a small, round disk with rings extending out from either side (**Fig. 34**). In 1610, Galileo, the first person to observe Saturn through a telescope, did not understand that what he was seeing were rings. Instead, he believed that Saturn had "ears." Saturn's rings are composed of billions of ice particles ranging in size from a speck of dust to the size of a house. The major division in Saturn's rings, called the Cassini Division, is occasionally visible through the ETX-60AT or ETX-70AT. Titan, the largest of Saturn's 18 moons can also be seen as a bright, star-like object near the planet.

## Deep-Sky Objects

Star charts can be used to locate constellations, individual stars and deep-sky objects. Examples of various deep-sky objects are given below:

**Stars** are large gaseous objects that are self-illuminated by nuclear fusion in their core. Because of their vast distances from our solar system, all stars appear as pinpoints of light, irrespective of the size of the telescope used.

**Nebulae** are vast interstellar clouds of gas and dust where stars are formed. Most impressive of these is the Great Nebula in Orion (M42), a diffuse nebula that appears as a faint wispy gray cloud. M42 is 1600 light years from Earth.

**Open Clusters** are loose groupings of young stars, all recently formed from the same diffuse nebula. The Pleiades is an open cluster 410 light years away (**Fig. 35**). Through the ETX-60AT or ETX-70AT, numerous stars are visible.

**Constellations** are large, imaginary patterns of stars believed by ancient civilizations to be the celestial equivalent of objects, animals, people, or gods. These patterns are too large to be seen through a telescope. To learn the constellations, start with an easy grouping of stars, such as the Big Dipper in Ursa Major. Then, use a star chart to explore across the sky.

**Galaxies** are large assemblies of stars, nebulae, and star clusters that are bound by gravity. The most common shape is spiral (such as our own Milky Way), but galaxies can also be elliptical, or even irregular blobs. The Andromeda Galaxy (M31) is the closest spiral-type galaxy to our own. This galaxy appears fuzzy and cigar-shaped. It is 2.2 million light years away in the constellation Andromeda, located between the large "W" of Cassiopeia and the great square of Pegasus.

## A Roadmap to the Stars

The night sky is filled with wonder and intrigue. You too, can enjoy exploring the universe simply by following a few pointers on a roadmap to the stars.

First, find the Big Dipper which is part of the constellation Ursa Major. The Big Dipper is usually easy to locate year round in North America.

Extending directly out from the far side of the Big Dipper's cup is the constellation Orion. One of the most exquisite areas of the winter sky, Orion is distinguished by Orion's belt, which is marked by three stars in a row. The Orion Nebula is located South of the belt and is one of the most observed deep-sky objects by amateur astronomers.

Extending from the "pointer stars" of the Big Dipper's cup is Polaris, the North Star. Extending from Polaris is the Great Square shared by the constellations Pegasus and Andromeda.

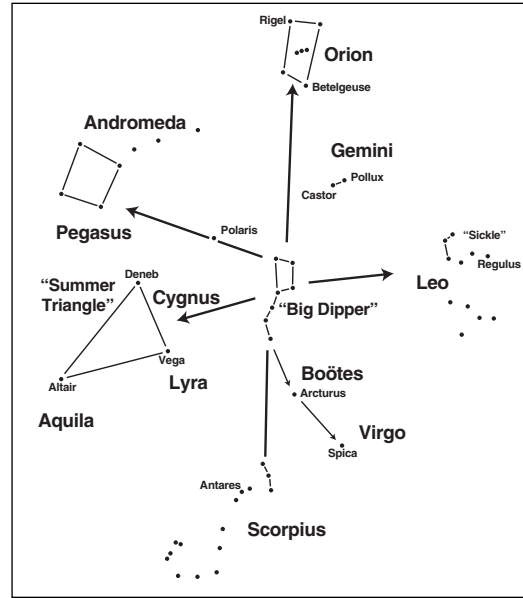

Fig. 36: Road Map to the Stars.

The Summer Triangle is a notable region in the sky to the left of the handle of the Big Dipper. The triangle is made up of three very bright stars: Vega, Deneb, and Altair.

By drawing an imaginary line outward from the handle of the Big Dipper, you reach the southern constellation "Scorpius." Scorpius curves to the left like the tail of a scorpion in the sky, or like letter "J."

Amateur astronomers commonly use the phrase "Arc to Arcturus and spike to Spica" to refer to the area directly off the arc in the handle of the Big Dipper. Follow the arc to Arcturus, the second brightest star in the Northern Hemisphere, then spike down to Spica, the 16th brightest star in the sky.

### Star Locator

The chart below lists bright stars with their R.A. and Dec coordinates, along with the Northern Hemisphere season when these stars are prominent in the night sky. This list aids the observer to find alignment stars at various times of the year. For example, if it is a midsummer evening in the Northern Hemisphere, Deneb in the constellation Cygnus, would be an excellent alignment star, while Betelgeuse could not be used because it is in the winter constellation Orion and thus, below the horizon.

Season	Star Name	Constellation	R.A.	Dec
Spring	Arcturus	Bootes	14h16m	19° 11"
Spring	Regulus	Leo	10h09m	11° 58"
Spring	Spica	Virgo	13h25m	-11° 10"
Summer	Vega	Lyra	18h37m	38° 47"
Summer	Deneb	Cygnus	20h41m	45° 17"
Summer	Altair	Aquila	19h51m	08° 52"
Summer	Antares	Scorpius	16h30m	-26° 26"
Fall	Markab	Pegasus	23h05m	15° 12"
Fall	Fomalhaut	Pisces Austrinus	s22h58m	-29° 38"
Fall	Mira	Cetus	02h19m	-02° 58"
Winter	Rigel	Orion	05h15m	-08° 12"
Winter	Betelgeuse	Orion	05h55m	07° 25"
Winter	Sirius	Canis Major	06h45m	-16° 43"
Winter	Aldebaran	Taurus	04h35m	16° 31"



## MEADE LIMITED WARRANTY

Every Meade telescope, spotting scope, and telescope accessory is warranted by Meade Instruments Corporation ("Meade") to be free of defects in materials and workmanship for a period of ONE YEAR from the date of original purchase in the U.S.A. and Canada. Meade will repair or replace a product, or part thereof, found by Meade to be defective, provided the defective part is returned to Meade, freight-prepaid, with proof of purchase. This warranty applies to the original purchaser only and is non-transferable. Meade products purchased outside North America are not included in this warranty, but are covered under separate warranties issued by Meade international distributors.

**RGA Number Required:** Prior to the return of any product or part, a Return Goods Authorization (RGA) number **must** be obtained from Meade by writing, or calling (949) 451-1450. Each returned part or product must include a written statement detailing the nature of the claimed defect, as well as the owner's name, address, and phone number.

This warranty is not valid in cases where the product has been abused or mishandled, where unauthorized repairs have been attempted or performed, or where depreciation of the product is due to normal wear-and-tear. Meade specifically disclaims special, indirect, or consequential damages or lost profit which may result from a breach of this warranty. Any implied warranties which cannot be disclaimed are hereby limited to a term of one year from the date of original retail purchase.

This warranty gives you specific rights. You may have other rights which vary from state to state.

Meade reserves the right to change product specifications or to discontinue products without notice.

This warranty supercedes all previous Meade product warranties.



ADVANCED PRODUCTS DIVISION

**Meade Instruments Corporation**

*World's Leading Manufacturer of Astronomical Telescopes for the Serious Amateur*  
6001 Oak Canyon, Irvine, California 92618 ■ (949) 451-1450

■ [www.meade.com](http://www.meade.com)

© 2000

Part no. 14-6896-01 06/00