

**VM-E455LA, VM-H655LA**  
**HITACHI**  
Instruction Manual

**8**

8mm Video Camcorder

**VM-E455LA**

**Hi 8**

HI 8 Video Camcorder

**VM-H655LA**

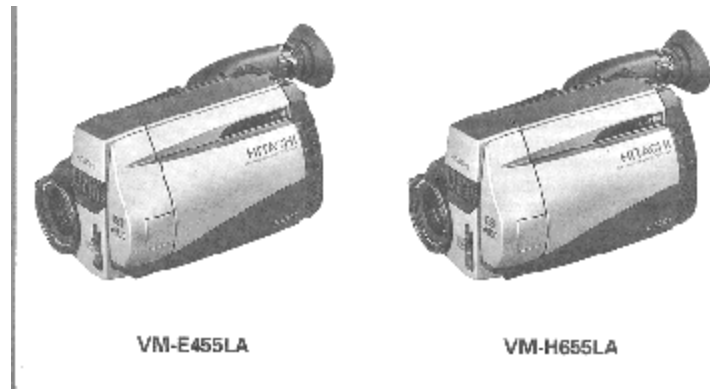

**HITACHI AMERICA, LTD.**  
**HOME ELECTRONICS DIVISION**  
1855 Dornoch Court  
San Diego, CA 92173  
Tel. 1-800-HATACHI  
(1-800-448-2244)

**HITACHI (HSC) CANADA INC.**  
6740 Campobello Road  
Mississauga, Ontario, L5N 2L8  
CANADA  
Tel. 1-800-HATACHI  
(1-800-448-2244)

Thank you for buying a Hitachi product. Please take time to become familiar with the manual and how it is set up. Keep it handy for feature reference.

QR30893 © Hitachi, Ltd. 1999

Printed in Japan KK-S(N)

**TABLE OF CONTENTS**

IMPORTANT SAFETY INFORMATION ..... 3

    Important Safeguards ..... 4

    Before You Begin..... 7

    Read This First ..... 8

    Features ..... 8

Getting Started..... 9

    Components and Accessories..... 9

    Optional RF Adaptor ..... 10

    Identifying Controls ..... 10

    Charging the Battery ..... 15

    Checking the Battery's Charge ..... 18

    Camcorder Power Sources ..... 19

    Inserting and Removing Cassettes ..... 20

    LCD Monitor..... 21

    Active Screen ..... 23

    Adjusting the Electronic Viewfinder..... 23

    Eyepiece Adjustment..... 24

    Adjustment the Hand Strap ..... 24

    Remaining Tape ..... 25

    Using the Linear Time Counter..... 26

    Display in Viewfinder or on LCD Monitor..... 26

    Setting the Date and Time ..... 27

Basic Techniques..... 28

    Making a Basic Recording ..... 28

    Using Instant Review ..... 30

    Using Auto Focus..... 30

    Using Manual Focus..... 31

    Using the Power Zoom..... 31

    Using the Digital Zoom..... 32

    Using the INST. ZOOM (instant Zoom) Button..... 32

    Using Macro..... 33

    Playback ..... 33

    Playing Back Your Recording on Your TV ..... 35

    Video Effects in Playback Mode..... 38

    Multi Playback ..... 39

Advanced Techniques ..... 40

    Advanced Techniques ..... 40

    Date Recording..... 40

    Creating and Recording a Title ..... 41

    Digital Effects Recording..... 46

    Using Digital Fade ..... 49

    Date Search ..... 51

    Using Memory..... 51

    Using Quick Edit..... 52

    Attaching the Optional Wide or Tele Converter Lens ..... 52

## IMPORTANT SAFETY INFORMATION

Demonstration Mode.....	53
Dubbing from the Camcorder to a VCR .....	53
Simple Programmable Edit (Edit remote control is optional accessory) .....	53
Using the Optional Edit Remote Control .....	57
Using Audio/ Video Dubbing .....	58
General Maintenance.....	59
Cleaning the Camcorder Heads.....	59
Cleaning the Lens and Picture Tube of the Electronic Viewfinder.....	60
Periodic Maintenance.....	60
Troubleshooting .....	61
Specifications .....	63

## IMPORTANT SAFETY INFORMATION

### For Your Safety

The CAM/OFF/VIDEO switch turns the camcorder on and off, leaving the date/time feature unaffected. If the unit is to be left unattended for a long period of time, turn the camcorder off and close the lens door.

**WARNING: TO PREVENT FIRE OR SHOCK HAZARD, DO NOT EXPOSE THIS UNIT TO RAIN OR MOISTURE.**

The camcorder and AC adapter/charger have the following caution marks.

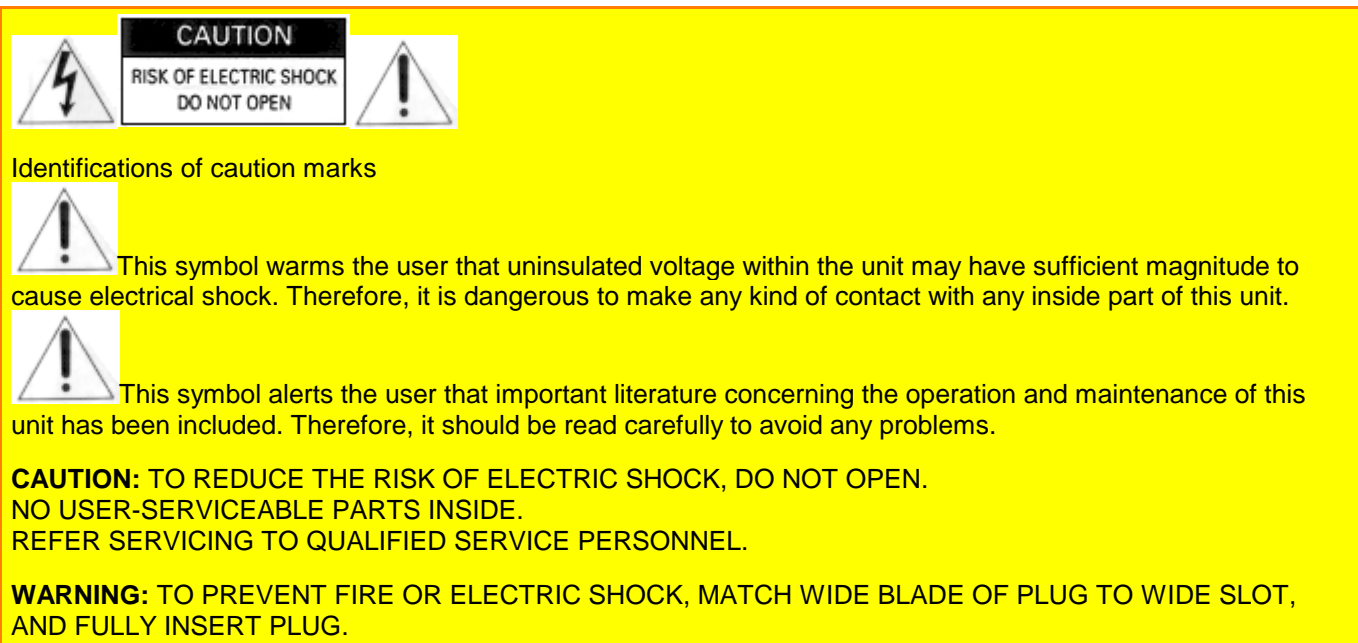

Identifications of caution marks

 This symbol warns the user that uninsulated voltage within the unit may have sufficient magnitude to cause electrical shock. Therefore, it is dangerous to make any kind of contact with any inside part of this unit.

 This symbol alerts the user that important literature concerning the operation and maintenance of this unit has been included. Therefore, it should be read carefully to avoid any problems.

**CAUTION: TO REDUCE THE RISK OF ELECTRIC SHOCK, DO NOT OPEN.  
NO USER-SERVICEABLE PARTS INSIDE.  
REFER SERVICING TO QUALIFIED SERVICE PERSONNEL.**

**WARNING: TO PREVENT FIRE OR ELECTRIC SHOCK, MATCH WIDE BLADE OF PLUG TO WIDE SLOT,  
AND FULLY INSERT PLUG.**

## Precautions

**WARNING:** Many television programs and films are copyrighted. In certain circumstances, copyright law may apply to private in-home videotaping of copyrighted materials.

This Class B digital apparatus meets all requirements of the Canadian ICES-003.

## IMPORTANT SAFETY INFORMATION

The liquid crystal display (LCD) panel is made by highly precise technology. More than 99.99% of its picture elements (pixels) are effective, but some (less than 0.01%) may appear as colored bright dots. This does not indicate a fault as the LCD panel stretches the limits of current technology.

### Information for VM-H655LA:

This camcorder can use **8** and **Hi 8** video cassettes. It automatically determines the loaded cassette is **8** or **Hi 8** and records and plays it back correctly.

**Warning:** This device complies with Part 15 of the FCC Rules. Operation is subject to the following two conditions: (1) This device may not cause harmful interference, and (2) this device must accept any interference received, including interference that may cause undesired operation.

**Note:** This equipment has been tested and found to comply with the limits for a Class B digital device, pursuant of Part 15 of the FCC Rules. These limits are designed to provide reasonable protection against harmful interference in a residential installation. This equipment generates, uses, and can radiate radio frequency energy and, if not installed and used in accordance with the instructions, may cause harmful interference to radio communications. However, there is no guarantee that interference will not occur in a particular installation. If this equipment does cause harmful interference to radio or television reception, which can be determined by turning the equipment off and on, the user is encouraged to try to correct by one or more of the following measures:

- Reorient or relocate the receiving antenna.
- Increase the separation between the equipment and receiver.
- Connect the equipment into an outlet on a circuit different from that to which the receiver is connected.
- Consult the dealer or an experienced radio/TV technician for help.

**Caution to the user:** Changes or modifications not expressly approved by the manufacture could void the user's authority to operate the equipment.

**"Note to CATV system installer:** This reminder is provided to call the CATV system installer's attention to Article 820-40 of the NEC that provides guidelines for proper grounding and, in particular, specifies that the cable ground shall be connected to the grounding system of the building, as close to the point of cable entry as practical".

### Notes:

- This unit uses 8mm video format cassettes.
- It records and plays back in the SP mode (14.3 mm/sec).
- It cannot record and play back in the LP mode (7.2 mm/sec).

## MOISTURE

Avoid operating your camcorder immediately after moving it from a cold place to a warm, humid place. Give the camcorder 2 to 3 hours to stabilize in the ambient conditions of the surroundings before inserting a cassette. When moved from a cold place to a warm, humid place, moisture may condense on the head drum inside the machine. This moisture could cause the tape to stick to the headwheel and damage the headwheel or tape. When a small amount of moisture is sensed, "TAPE" flashes in the viewfinder or LCD monitor. Remove the cassette and set the CAM/OFF/VIDEO switch to OFF, then wait for about one hour.

## Important Safeguards

In addition to the careful attention devoted to quality standards in the manufacture of your video product, safety is a major factor in the design of every instrument. But, safety is your responsibility too.

This page lists important information that will help to assure your enjoyment and proper use of a Video camcorder and accessory equipment. Please read it carefully before operating your video product and keep it in a handy place for future reference.

## **INSTALLATION**

**1 Read and Follow Instructions** -- All the safety and operating instructions should be read before the video product is operated. Follow-all operating and use instructions.



**2 Retain Instructions** -- The safety and operating instructions should be retained for future reference.

**3 Heed Warnings** -- Comply with all warnings on the video product and in the operating instructions.

**4 Polarized Plug** -- This video product is equipped with a polarized alternating-current line plug (a plug having one blade wider than the other). This plug will fit into the power outlet only one way. This is a safety feature. If you are unable to insert the plug fully into the outlet, try reversing the plug. If the plug should still fail to fit, contact your electrician to replace your obsolete outlet. To prevent electric shock do not use this polarized plug with an extension cord, receptacle or other outlet unless the blades can be fully inserted without blade exposure. If you need an extension, use a polarized cord.



**5 Power Sources** -- This video product should be operated only from the type of power source indicated on the marking label. If you are not sure of the type of power supply to your home, consult your video dealer or local power company. For video products intended to operate from battery power, or other sources, refer to the operating instructions.

**6 Overloading** -- Do not overload wall outlets and extension cords as this can result in a risk of fire or electric shock. Overloaded AC outlets and extension cords are dangerous, and so are frayed power cords, damaged or cracked wire insulation and broken plugs. They may result in a shock or fire hazard. Periodically examine the cord and have it replaced by your service technician if appearance indicates damage or deteriorated insulation.



**7 Power-Cord Protection** -- Power-supply cords should be routed so that they are not likely to be walked on or pinched by items placed upon or against them, paying particular attention to cords at plugs, convenience receptacles, and the point where they exit from the appliance.

**8 Ventilation** -- Slots and openings in the cabinet are provided for ventilation to ensure reliable operation of the video product and to protect it from overheating. These openings must not be blocked or covered. The openings should never be blocked by placing the video product on a bed, sofa, rug or other similar surface. This video product should never be placed near or over a radiator or heat register. This video product should not be placed in a built-in installation such as a bookcase or rack unless proper ventilation is provided or the video product manufacturer's instructions have been followed.

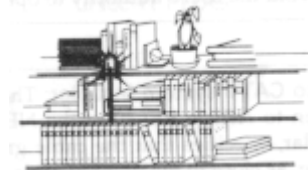

**9 Attachments** -- Do not use attachments unless recommended by the video product manufacturer as they may cause hazards.

## IMPORTANT SAFETY INFORMATION

**Caution:** Maintain electrical safety. Powerline operated equipment or accessories connected to this unit should bear the UL listing mark or CSA certification mark on the accessory itself and should not have been modified so as to defeat the safety features. This will help avoid any potential hazard from electric shock or fire. If in doubt, contact qualified service personnel.

**10 Water and Moisture** -- Do not use this video product near water - for example, near a bath tub, wash bowl, kitchen sink, or laundry tub, in a wet basement, or near a swimming pool, and the like.

**11 Accessories** -- Do not place this video product on an unstable card, stand, tripod, bracket, or table. The video product may fall, causing serious injury to a child or adult, and serious damage to the appliance. Use only with a cart, stand, tripod, bracket, or table recommended by the manufacturer, or sold with the video product. Any mounting of the product should follow the manufacturer's instructions, and should use a mounting accessory recommended by the manufacturer.

**11A** An appliance and cart combination should be moved with care. Quick stops, excessive force, and uneven surfaces may cause the appliance and cart combination to overturn.



### IMPORTANT SAFETY INFORMATION (cont.)

**12 Outdoor Antenna Grounding** -- If an outside antenna or cable system is connected to the video product, be sure the antenna or cable system is grounded so as to provide some protection against voltage surges and built-up static charges. Section 810 of the National Electrical Code, ANSI/NFPA No. 70, provides information with respect to proper grounding of the mast and supporting structure, grounding of the lead-in wire to an antenna discharge unit, size of grounding conductors, location of antenna-discharge unit, connection to grounding electrodes, and requirements for the grounding electrode. See example below:

### EXAMPLE OF ANTENNA GROUNDING

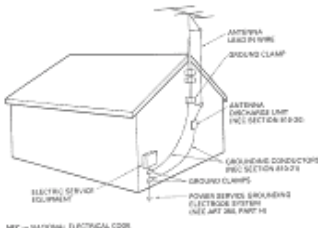

**13 Power Lines** -- An outside antenna system should not be located in the vicinity of overhead power lines or other electric light or power circuits, or where it can fall into such power lines or circuits. When installing an outside antenna system, extreme care should be taken to keep from touching or approaching such power lines or circuits as contact with them might be fatal. Installing an outdoor antenna can be hazardous and should be left to a professional antenna installer.

## USE

**14 Cleaning** -- Unplug this video product from the wall outlet before cleaning. Do not use liquid cleaners or aerosol cleaners. Use a damp cloth for cleaning.

**15 Object and Liquid Entry** -- Never push objects of any kind into this video product through openings as they may touch dangerous voltage points or short-out parts that could result in a fire or electric shock. Never spill liquid of any kind on the video product.

## IMPORTANT SAFETY INFORMATION



**16 Lightning** -- For added protection for this video product during a lightning storm, or when it is left unattended and unused for long periods of time, unplug it from the wall outlet and disconnect the antenna or cable-system. This will prevent damage to the video product due to lightning and power-line surges.



## SERVICE

**17 Servicing** -- Do not attempt to service this video product yourself as opening or removing covers may expose you to dangerous voltage or other hazards. Refer all servicing to qualified service personnel.

**18 Conditions Requiring Service** -- Unplug this video product from the wall outlet and refer servicing to qualified service personnel under the following conditions.

- When the power-supply cord or plug is damaged
- If liquid has been spilled, or objects have fallen into the video product.
- If the video product has been exposed to rain or water.
- If the video product does not operate normally by following the operating instructions. Adjust only those controls that are covered by the operating instructions. Improper adjustment of other controls may result in damage and will often require extensive work by a qualified technician to restore the video product to its normal operation.
- If the video product has been dropped or the cabinet has been damaged.
- When the video product exhibits a distinct change in performance - this indicates a need for service.

**19 Replacement Parts** -- When replacement parts are required, have the service technician verify that the replacements he uses have the same safety characteristics as the original parts. Use of replacements specified by the video product manufacturer can prevent fire, electric shock or other hazards.

**20 Safety Check** -- Upon completion of any service or repairs to this video product, ask the service technician to perform safety checks recommended by the manufacturer to determine that the video product is in safe operating condition.

**21 Heat** -- The product should be situated away from heat sources such as radiators, heat registers, stoves, or other products (including amplifiers) that produce heat.

---

## Before You Begin

Any problems that occur as a result of any of the following conditions will not be covered by our warranty.

**Do not shoot the sun directly. Otherwise, the lens will be faulty.**

Be careful that no water, dust or sand enters the camcorder and all accessories.

When you shoot at a scene which contains an extremely bright object such as the sun or a light source, a bright vertical bar may appear in the picture.

Your camcorder is functioning properly, but the solid-state pickup device (C.C.D) usually causes this as an inherent characteristic. Try to avoid shooting an excessive bright object directly.

Be sure not to leave the camcorder in a place where the temperature exceeds 140°F (60°C), or the pickup

## IMPORTANT SAFETY INFORMATION

device may be damaged.

Dangerous includes:

- Inside a car with the windows closed and in direct sunshine.
- Near heating appliances.

Do not leave the viewfinder lens and the liquid crystal display (LCD) screen facing sunlight for a prolonged period, or the phosphorescent surface of the cathode ray tube and the LCD panel may be damaged.

---

## Read This First

*To guide you, we've included:*

- An "Important Safety Information" section containing important cautions for your family's safety as well as instruction for getting your video camcorder ready for use. Please read and understand this section thoroughly before moving on.
- A "Getting Started" section to familiarize yourself with the controls and prepare you for recording.
- A "Basic Techniques" section to allow you to use your video camcorder quickly and confidently before advancing to the more sophisticated features of the Hitachi VM-E455LA/VM-H655LA.
- "Advanced Techniques" to help you with some of the exciting, sophisticated features of the Hitachi VM-E455LA/VM-H655LA. We hope you will take the time to learn about these functions since they have been designed for you. You can use the video camcorder without reading this section.
- A "General Maintenance" section to help keep your purchase in good repair.

*We want this manual to be as helpful as possible, so it includes two easy ways to find the information you need:*

- A quick index for the information you use most often (this page).
- A detailed table of contents directing you to specific information quickly (page 8).

*Get to know your video camcorder by using this manual, and get to know Hitachi. We appreciate your business.*

## Quick Index

Charging the Battery .....	14
Setting the Date and Time .....	24
Making a Basic Recording .....	26
Zooming .....	28
PlayBack .....	30
Dubbing from Camcorder to VCR .....	48

---

## Features

- Easy to use
- 2.5-inch color liquid display (LCD) monitor with speaker
- Active screen
- Perfect power (Lithium-ion battery)
- 100X zoom ratio
- 200X digital zoom (with instant zoom)
- Digital effect
- Fade in / Fade out
- Instant zoom
- Recorded date search



## Getting Started

- Automatic title recording
- Video effects
- Multi playback (PAL60 conversion)

### Types of differences

	VM-E455LA	VM-H655LA
System	<b>8</b>	<b>Hi 8</b>

## Getting Started

*This section guides you through the initial preparation of the camcorder. None of these processes are complex. Set aside some time, relax, and familiarize yourself with this quality instrument.*

*Enjoy getting to know all about your Hitachi 8mm camcorder. The more comfortable and familiar you are with the machine and its features, the more you can make it do for you. Let's get started!*

*It is crucial that you read and understand all the safety instructions before you begin. If you haven't read the safety instructions yet, please take the time to do so now.*

## Components and Accessories

Check that you have all the following components and accessories before proceeding.

1. Audio/video output cable
2. Battery pack
3. AC adapter/charger
4. Batteries for date/title

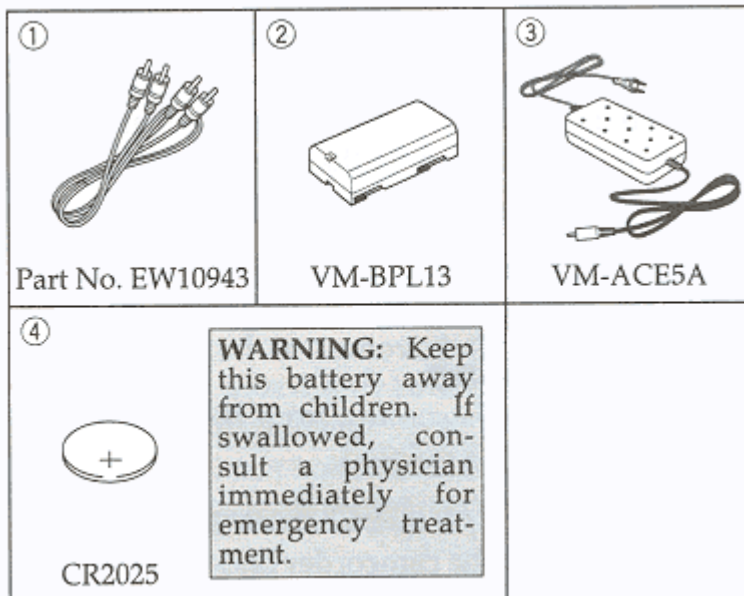

## Optional RF Adaptor

If you wish to connect this camcorder to a television that does not have audio/video input jacks you will need to use the optional RF adaptor model VM-RF86A (R).

## Identifying Controls

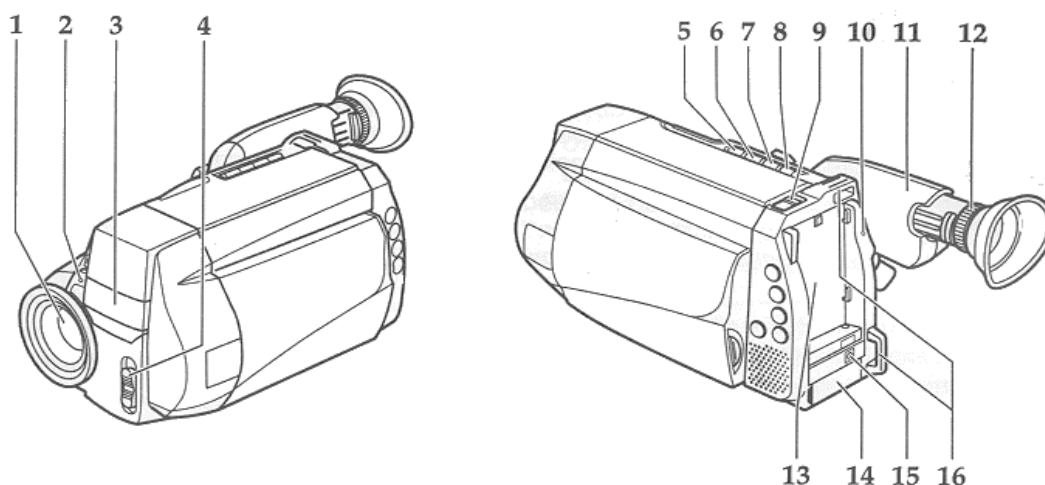

### 1. Lens Door

The door will automatically open when the CAM/ OFF/VIDEO switch is set to "CAM". Setting the switch to "OFF" will close the door.

### 2. Record Indicator

This indicator flashes when the camcorder is recording.

### 3. Microphone

Sensitive to sounds coming from the direction in which the camera is pointed.

### 4. CAM/OFF/VIDEO Power Switch

This switch turns the camcorder on and off. Set the switch to CAM for camera recording, and to VIDEO for playback. Hold down the small red button as you slide the switch to CAM or VIDEO. You do not need to hold down the red button to slide the switch to OFF.

### 5. F.FWD Button

Use this button to fast forward tapes or for visual search. During visual search the camcorder fast forwards at approximately 9 times normal playback speed. During fast forward, press and hold this button to visually scan the tape forward at 19 times the normal playback speed. ("Using Forward and Reverse Search", p31) Also use this button to set date and time and create a title ("Creating and Recording a Title", p39).

### 6. PLAY Button

Use to play back recorded tapes and create a title. ("Creating and Recording a Title", p39)

### 7. REW/REVIEW Button

Use this button to fast rewind tapes or for visual search. During visual search the camcorder rewinds at approximately 7 times normal playback speed. During rewind, press and hold this button to visually scan the tape backwards at 17 times the normal playback speed. ("Using Forward and Reverse Search", p31) Also use this button to set date and time and create a title ("Creating and Recording a Title", p39). Furthermore, use this button to review the last few seconds of the tape you are recording.

## 8. STOP Button

Use this button to stop playback, fast forward, or reverse. Also use this button to set date and time and create a title. ("Creating and Recording a Title", p39).

## 9. BATTERY Release Lever

Releases the battery attached to camcorder.

## 10. CHARGE Indicator

When the battery is being charged, this indicator will flash or light to show the charged level as a reference

## 11. Electronic Viewfinder

## 12. Diopter Control

To use the electronic viewfinder, pull the eye cup all the way, and then turn this control for your optimum focus adjustment

## 13. Power Supply Attachment Section

Attach the battery here

## 14. AUDIO/VIDEO Output Jacks (Behind the jack cover)

Use this jack to connect the camcorder to a VCR or television

- Connect the yellow plug of the audio/video cable to the yellow jack (VIDEO OUT) and the white plug to the white jack (AUDIO OUT).

## 15. DC IN Jack

Plug in the AC adaptor here to charge a battery or power the camcorder from AC outlet. In addition, connect the optional car battery cord to this jack, in which case, you will need a DC cord (optional).

## 16. Shoulder Strap Slots

Attach a shoulder strap here.

## 17. OPEN Button

Push this button to open the LCD monitor.

## 18. Bright Control Buttons

Use this to adjust the brightness of the LCD monitor screen

## 19. LCD Monitor

You can view the pictures as they are being recorded and play them back immediately after recording on the LCD screen.

## 20. Cassette Holder

A power source must be connected to the camcorder before a cassette can be inserted or removed.

## 21. EJECT Button

Press this button to open the cassette holder. A power source must be connected before cassettes can be inserted or removed though the CAM/ OFF/VIDEO switch maybe set to OFF

**Note:** The EJECT button is inoperable unless the LCD monitor is completely open.

## 22. Speaker

You can listen to the recorded sound.

**Note:** No sound is heard when the LCD monitor is closed.

## 23. FOCUS/VOL. (volume) Control Buttons

When the CAM/OFF/VIDEO switch is set to CAM, these buttons will be the focus control buttons. Press them simultaneously to select manual or automatic focusing. To control focus manually, press the ▲ or ▼ button to bring the subject into focus. When manual focus has been engaged, "FOCUS" will appear in the viewfinder or on the LCD monitor.

When you are viewing playback pictures on the LCD monitor with the CAM/OFF/VIDEO switch set to VIDEO, these buttons can be used to control the volume of the built-in speaker

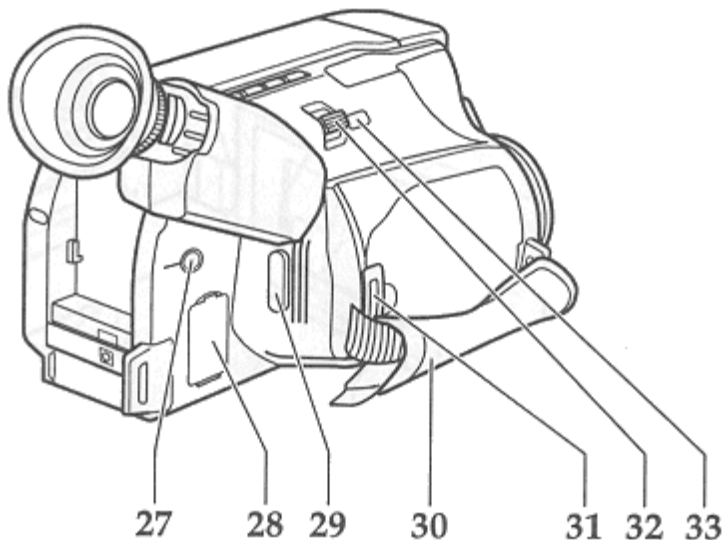

### 24. DATE/DISP Button

When the CAM/OFF/VIDEO switch is set to CAM, this button can be used as the DATE or DISPLAY button: set the date and time, and select the date display you want to record ("Setting the Date and Time", p24 and "Date Recording", p38).

In the VIDEO mode, the DATE/DISP. button is used as the DISPLAY button ("Display in Viewfinder or on LCD Monitor", p22).

**Note:** Be sure to insert the clock battery before setting the date and time or creating a title.

### 25. EFFECTS Button

Use this button to digitally process the image you are going to record or the playback image. During recording, you can select among six modes: 16x9, negative/ positive, X400 digital zoom, half-mirRor, mosaic, or art ("Digital Effects Recording", p42).

During playback, you can select among three modes: 16x9, art, or sepia ("Video Effects in Playback Mode", p35).

### **26. FADE Button**

The FADE button features six modes; white fade, wipe fade, mosaic fade, art fade, zoom fade and black-and-white fade ("Using Digital Fade," p44).

### **27. PAL60 Button (Multi Playback)**

Use this button when connecting the camcorder to a PAL TV which handles PAL60 mode signal and has vertical sync adjustment circuitry for 60Hz.

Notes:

- Make sure "PAL60" is not displayed when connecting the camcorder to an NTSC TV for playback, or monitoring the playback picture on the camcorder's LCD monitor. If "PAL60" is displayed in the above cases, no color will appear in the picture.
- The PAL60 button is effective during playback only.
- See TV instruction manual for details about setting of PAL60 mode.
- Depending on the state of the tape recorded, the PAL60 button may not operate normally.
- Tape recorded on PAL system cannot be played back.
- The PAL60 mode will be released when the camcorder is turned off.

### **28. Audio/Video Output Jack (Behind the jack cover)**

Use this jack to connect the camcorder to a television ("Connecting to a Television without Audio In and Video In Jacks", p34).

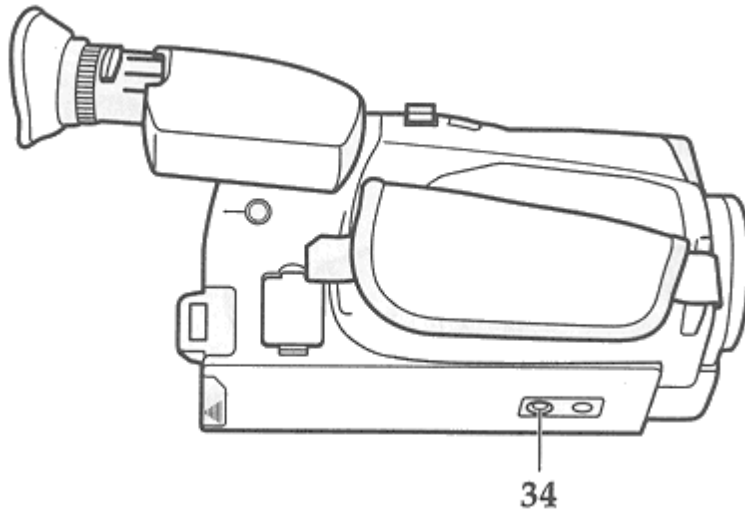

**29. Start/Stop Button**

When the CAM/OFF/VIDEO switch is in CAM press this button to start recording. When pressed a second time the camera pauses.

During playback use this button to stop the tape temporarily. Pressing a second time resumes normal playback.

**30. Hand Strap**

Refer to page 21.

**31. Clock Battery Compartment**

Pull the battery holder and install the clock battery (provided). (See "Loading Clock Battery" on page 21.)

**32. Power Zoom Control**

Use this to zoom automatically ("Using the Power Zoom", p28).

**33. INST. ZOOM (instant Zoom) Button**

Use this button to magnify the image being recorded 1.5 times.

**34. Tripod Mounting Threaded Socket**

Use this threaded socket to mount the camcorder to a tripod.

## Charging the Battery

The first step is to set the battery for charging. To charge the battery, attach it to the camcorder, and connect the VM-ACE5A AC adaptor. Charge the battery at a temperature range of 50°F (10°C) - 86°F (30°C) to prevent damage to the battery.

**Note:** This camcorder operates with a lithium ion battery such as VM-BPL13/VM-BPL27/VM-BPL30/VM-BPL60.

**Note:** We cannot be responsible for any malfunctions of the camcorder which occur when you use battery packs other than those specified.

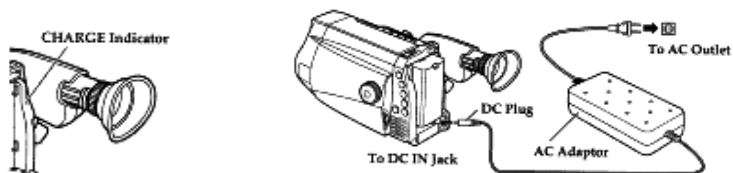

Charge the battery on a flat surface this is free of vibration.

1 Make sure the CAM/OFF/VCR switch is set to OFF position.



2 Attach the battery pack to the camcorder.

- Align the bottom of the battery with mark  on the camcorder so that the battery fits into the grooves. Then slide the battery downward, as illustrated.



**Note:** Always attach a battery only by the procedure described here. Attaching a battery forcibly could damage it.

3 Plug the AC adaptor power cord into an AC outlet.

Make sure that the wide blade fits into the wide slot. If it doesn't fit, try reversing it. If the blades still do not fit fully into the outlet, either contact an electrician to replace your obsolete outlet, or use a polarized cord or outlet

accessory.

4 Connect the AC adaptor DC plug to the DC IN jack of the camcorder.

Charging will start within five seconds. During charging, the CHARGE indicator of the camcorder will flash or light to give you a reference of the charged level.

**Note:** If the CHARGE Indicator flashes once every two seconds, the battery could be defective.

**Note:** The CHARGE indicator will not light at all when the AC adaptor is defective.

**Note:** You can use the battery before it is completely charged.

**Note:** When charging is complete, the CHARGE indicator on the camcorder will light. IF the fully charged battery is removed and then reattached, the camcorder will again enter the charge mode, and the CHARGE indicator will flash. It will take a few minutes for the camcorder to enter the charge complete status.

**Note:** Charging at low temperatures will decrease charge capacity.

5 After charging is complete, disconnect the AC adaptor DC plug from the camcorder.

6 Disconnect the AC plug from the AC outlet.

7 Detach the battery from the camcorder.

**Note:** Always remove the battery from the camcorder after use.

**Note:** Charging is not done when the CAM/ OFFLINE switch of the camcorder is set to CAM or VIDEO, However, if recording pause continues for more than 5 minutes in the CAM mode, the camcorder will automatically turn off, after which charging will start.

**Note:** If the DC plug is disconnected when the battery is attached and the CAM/OFF/VIDEO switch is set to CAM or VIDEO, the camcorder will turn off once, but then automatically turn on again, Note that the battery will discharge if the camcorder is left as is.

## Removing the Battery Pack

Slide the BATTERY release lever in the direction of the arrow and hold it; then slide the battery to the upper side and remove.

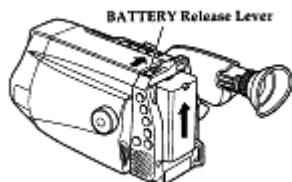

## Reference of Charged Level

You can know the approximate charge level of battery by observing how the CHARGE indicator of camcorder flashes or lights:

Charge level	CHARGE indicator
0-50% charge	Flashes once at approx. one-second intervals.
50-75% charge	Flashes twice at approx. one-second intervals.



<b>More than 75% charge</b>	Flashes three times at approx. one-second intervals.
<b>Full charge</b>	Steady light

## Charging Time

<b>Pack</b>					
<b>Charging</b>		130 .	230 min.	260 min.	460 min.
		70 min.	140 min.	160 min.	320 min.

<b>Battery</b>	<b>VM-BPL13</b>	<b>VM-BPL27</b>	<b>VM-BPL30</b>	<b>VM-BPL60</b>
<b>Charging</b>				
<b>Full Charge</b>	170 min	300 min	330 min	590 min
<b>75% Charge</b>	100 min	190 min	210 min	410 min

## Operating Time

The camcorder operating time depends on how often you turn power on/off and use start/stop and zoom.

### Continuous Recording

**EVF:** when using the viewfinder

**LCD:** when using the LCD monitor

<b>Battery</b>	<b>VM-BPL13</b>	<b>VM-BPL27</b>	<b>VM-BPL30</b>	<b>VM-BPL60</b>
<b>EVF</b>	160 min.	330 min.	370 min.	760 min.
<b>LCD</b>	120 min.	260 min.	290 min.	630 min.

### Typical Recording

**EVF:** when using the viewfinder

**LCD:** when using the LCD monitor

<b>Battery</b>	<b>VM-BPL13</b>	<b>VM-BPL27</b>	<b>VM-BPL30</b>	<b>VM-BPL60</b>
<b>EVF</b>	90 min.	190 min.	200 min.	420 min.
<b>LCD</b>	70 min.	150 min.	170 min.	380 min.

### Notes on the Battery

- It is recommended that the battery always be left in the discharged state when not in use, and charged before you use it.
- Avoid storing a fully charged battery, and do not store it in a place where the temperature is high: this will damage the battery.

## Getting Started

- Do not operate the battery at temperature below 14°F (-10°C) or above 113°F (45°C). At extremely low temperatures operation time decreases, while at high temperature the battery may be damaged,
- Do not attach a hot battery to the camcorder. Allow it to cool.

**THERE ARE NO USER-SERVICEABLE PARTS  
INSIDE THE BATTERY  
OR AC ADAPTOR.**

**THROWING THE BATTERY INTO FIRE  
OR EXPOSING IT TO EXCESSIVE HEAT  
(ABOVE 140°F [60°C])  
MAY CAUSE INJURY.**

**SHORTING THE BATTERY'S TERMINAL  
INCREASES RISK OF FIRE OR  
ELECTRICAL SHOCK.**

## Checking the Battery's Charge

A battery charge indicator is located on the upper right corner of the viewfinder or LCD monitor. One of six symbols displays when the battery is used.

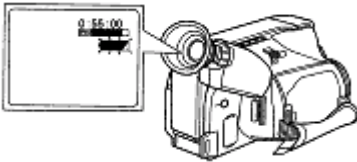

**Note:** The battery charge indicator does not appear when the camcorder is powered by the AC adaptor.



This flashing symbol indicates a battery nearly out of power. Use an alternative power source or charge the battery before continuing to use the camcorder.

## Knowing Remaining Battery Power Time

If you use the VM-BPL30 lithium-ion battery (optional) to power the camcorder, you can find out how much camcorder operating time remains, with the battery.

The VM-BPL30 measures the battery consumption, calculates the remaining battery time, and displays it (in minutes) in the viewfinder or on the LCD monitor. Since the camcorder power consumption varies according to how frequently autofocusing or zooming is used, the displayed time may decrease or increase several minutes at a time, or may not change for some time.



**Note:** The remaining battery time will appear 10-15 seconds after the CAM/OFF/VIDEO switch is set to CAM; it will not appear in the VIDEO position.

**Note:** When the remaining time decreases to 5 minutes or less, the time display will disappear. We recommend that you replace the battery earlier.

## Getting Started

**Note:** If you connect the VM-BPL30 battery with the remaining battery time of 5 minutes or less, the time will not be displayed.

**Note:** If the correct remaining time does not appear, use up the battery attached to the camcorder, and then fully charge it.

**Note:** If you repeat charging and discharging the battery before using it up, the correct remaining time may not be displayed.

**Note:** If the battery is used at low temperatures, the actual operating time with battery will be substantially different from the displayed time, and the correct time may not appear.

**Note:** If the battery which has been used at low temperature is subsequently used at normal temperature, display of remaining battery time will be incorrect. For display of correct remaining time, fully charge the battery.

**Note:** The remaining battery time will not appear when you are recording an image of yourself, or the LCD monitor is put back to camcorder with its screen facing to the side.

**Note:** If you eject and reinsert cassette after the battery is discharged, power will shut off midway and the camcorder will stop. When the battery is discharged, immediately remove it from the camcorder and charge it again.

**Note:** When the VM-BPL30 battery is used, the battery charge indicator "☐" may not match the remaining battery time display (in minutes). In this case, refer to the remaining time display when using the camcorder.

### To display the correct remaining battery time on camcorder

- Fully charge the battery before use.
- Turn the camcorder on and leave it pointing at a still subject for about 30 seconds. Do not move the camcorder during this time.
- If display does not change some time, open and close the LCD monitor while you are using the camcorder.

---

## Camcorder Power Sources

*You can use the charged battery pack, AC adaptor (provided) or car battery cord (optional) to power the camcorder, After use, be sure to remove the power supply,*

### Using Battery Pack

1 Attach the charged battery pack to the camcorder. (See pages 16 and 17 for attachment and charging of battery pack.)

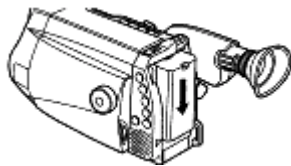

### Using the AC Adaptor

*Please ensure that the CAM/OFF/VIDEO switch is in the OFF position whenever attaching or detaching any power supply (ie. battery, AC adaptor, etc.).*

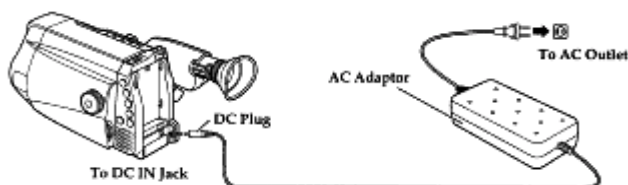

## Getting Started

1 Plug the AC adaptor power cord into an AC outlet. Make sure that the wide blade fits into the wide slot. If it doesn't fit try reversing it. If you still cannot make fit the blades fully into the outlet either contact an electrician to replace your obsolete outlet, or use a polarized cord or outlet accessory.

2 Connect the DC plug of the AC adaptor to the DC IN jack of the camcorder.

**Note:** The AC adaptor can be used around the world. An AC plug adaptor is required in some foreign countries. If you need one purchase it at your Hitachi distributor.

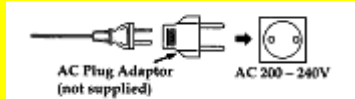

## Using a Car Battery

The camcorder can be powered with a car battery by using an optional car battery cord (Hitachi VM-CC80A) to plug the camcorder into the car's cigarette lighter socket. Please ensure that the CAM/OFF/VIDEO switch is in the OFF position whenever attaching or detaching any power supply (ie. battery, AC adaptor, etc.).

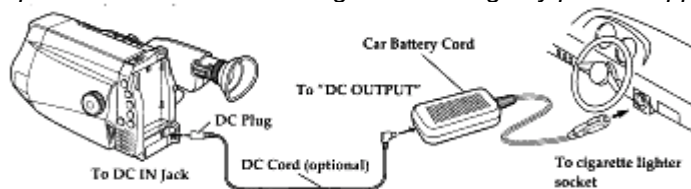

1 Plug the car battery cord into the car's cigarette lighter socket.

2 Connect one end of the DC cord (optional) to the DC IN jack of the camcorder. Connect the other end of the DC cord to the DC OUTPUT of the car battery cord.

**Note:** You need the optional VM-CC80A KIT

**Note:** Only use the car battery cord with cars having 12/24 volts negative ground system.

**Note:** You cannot use the car battery cord to charge a battery.

---

## Inserting and Removing Cassettes

A power source must be connected before inserting or removing cassettes. Once connected, cassettes can be inserted or removed whether the CAM/OFF/VIDEO switch is on or off.

### Inserting a Cassette

1 Press the OPEN button to open the LCD monitor

2 Press the EJECT button. "  EJECT" will appear on the LCD monitor, and the cassette door will open automatically.

**Caution:** Do not touch the cassette door when a cassette is being loaded or unloaded. If your finger is caught by the metal section of holder, it could be cut.

**Note:** Cassette cannot be inserted or ejected unless the LCD monitor is open: Open the monitor until it is at right angles to the camcorder.

## Getting Started

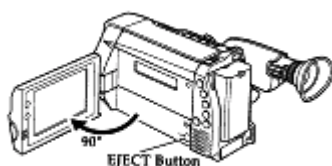

3 Place the cassette in the cassette holder so that the transparent window faces away from the body of the camcorder and the spry toward the body of the camcorder.

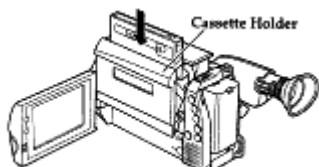

4 Push the cassette door, which is embossed PUSH, until it "clicks" into place. The camcorder automatically closes.

**Note:** The camcorder will automatically close the top of the cassette compartment. Do not press the door down, or you may damage your camcorder.

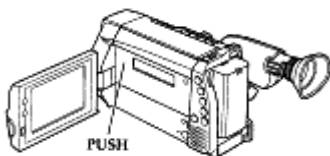

**Note:** If "TAPE" flashes in the viewfinder or on the LCD monitor, remove the cassette and check that the tape is not damaged, is not slack or no dust adheres to it, etc. After making sure that there is no abnormality, reinsert the cassette. If "TAPE" reappears, see "Troubleshooting" on page 57.

**Note:** If the tape is near the winding end, it may take longer to load it.

### Removing a Cassette

Press the EJECT button. "EJECT" will appear on the LCD monitor, and the cassette door will open automatically. Remove the cassette.

### Protecting Recorded Material

Protect 8mm cassettes from accidental erasure by sliding the tab on the side of the cassette toward the opposite side until the tab is completely visible. Slide the tab in the opposite direction, until the tab disappears, to record on the cassette again.

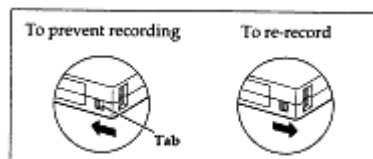

---

## LCD Monitor

When using the LCD monitor during recording and playback, you can adjust the brightness of its screen and the angle of the monitor.

## Opening the LCD Monitor

1 Press the OPEN button to open the LCD monitor.

**Note:** Opening or closing the LCD monitor switches the picture to appear on the LCD monitor or In the viewfinder.

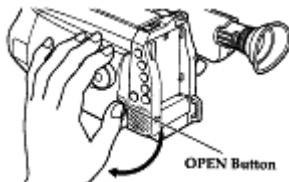

## Adjusting the Brightness of the LCD Screen

**Note:** Even when the picture on the LCD monitor is adjusted, the recorded video will not change.

1 Load the battery. ("Camcorder Power Sources", P17.)

2 Press the red button on the CAM/OFF/ VIDEO switch as you slide it to CAM or VIDEO.



3 Use the brightness control buttons to adjust the brightness of the LCD screen. When either button is pressed, the brightness control display will appear on the LCD monitor for about 5 seconds. Press ▲ to increase brightness, or ▼ to decrease it. After 5 seconds, the adjustment display will automatically disappear.

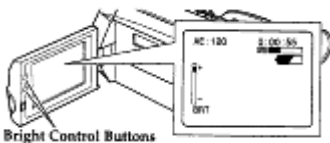

## Range in which the LCD Monitor can be moved

Viewed from Top

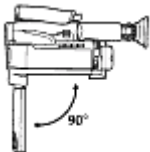

View Viewed from Side

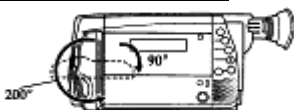

View Viewed from Side



- If the LCD monitor is turned 90° so that it faces the same direction as the lens when the camera signal is being recorded during recording, recording pause, instant review, editing, A/V dubbing or A/V dubbing pause, the image on the monitor screen will become a mirror image and the viewfinder will turn on. The on-screen display on the LCD monitor will also be as if reflected on a mirror.
- If the LCD monitor is closed with the screen facing to the side, the mirror image will change to a normal image when the LCD monitor has been closed about 45°; also, the viewfinder will turn off.

### Cautions on LCD Monitor Screen

- Do not touch the LCD screen with your fingers as the screen could get dirty and the picture will not be seen clearly. If the LCD screen becomes dirty, use a soft cloth to wipe off the dirt.
- If the camcorder is used in a cold place and becomes too cold, the LCD screen will be dim for a while after the power is turned on. When the temperature inside the camcorder rises, the brightness of the picture will become normal.
- Do not hold by the LCD monitor as this could cause a malfunction.
- Open the LCD monitor by 90° before changing its direction. If you were to attempt to invert its direction before opening it completely, it could cause a malfunction.
- The LCD monitor cannot be closed if it is tilted.
- Close the LCD monitor after making sure it is parallel with the camcorder. If you were to close the monitor while it faces the same direction as the lens or it is diagonal, it could damage the LCD monitor.
- Do not disassemble the LCD monitor as this might cause a malfunction.
- When opening the LCD monitor, be careful that no water droplets adhere the monitor screen and that no water or dust enters the camcorder through the gap as it could cause a malfunction.

---

## Active Screen

The camcorder automatically brightens the backlight of the LCD monitor when you are recording a bright subject outdoors, so that the LCD screen is easy to see.

**Note:** When you record a bright subject outdoors, the camcorder operating time will be less than when recording indoors.

**Note:** Even if you record outdoors, the LCD monitor backlight may not brighten, if you are aiming at a dark subject.

**Note:** While the battery charge indicator "  " is flashing, the Active Screen function will not operate.

---

## Adjusting the Electronic Viewfinder

The electronic viewfinder adjusts simply by pivoting it to a position where it is comfortable and easy to see through. Place the viewfinder back in its original position before storing the camcorder in its case or carrying the camera recorder around to avoid damaging the viewfinder or camcorder.

To replace the viewfinder, retract the eye cup stem or turn over the eye cup.

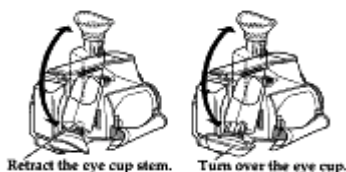

**CAUTION:**

Do not hold the unit by the electronic viewfinder when carrying as this could cause a malfunction.

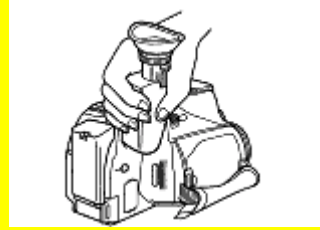

---

## Eyepiece Adjustment

To use the electronic viewfinder, grasp the knobs on both sides of the eye cup stem and pull the eye cup all the way, then turn the diopter control for your optimum focus adjustment. Since the eye cup has already been pulled out at the factory, in present condition, only adjustment of the diopter control is necessary.

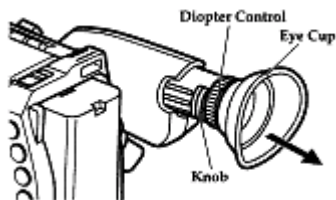

**Note:** Be sure to pull out the eye cup all the way so that you can see the subject in the viewfinder clearly.

**Note:** Hold the knobs on both sides of the eye cup stem to pull out the eye cup.

**Note:** The eye cup stem can be retracted when the camcorder is being carried.

---

## Adjustment the Hand Strap

Adjust the hand strap to best fit your hand.

**Note:** After adjustment, close the hand strap's pad securely.

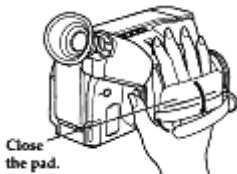

## Loading Clock Battery

*Install the battery to prevent misplacing it.*

1 Pull out the battery holder using such as coins.



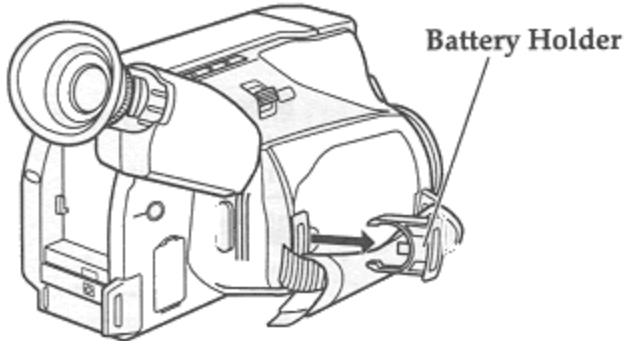

2 Insert the battery with the "+" terminal facing up.

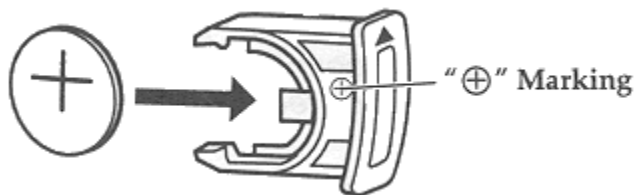

3 Fully insert the battery holder into the camcorder.

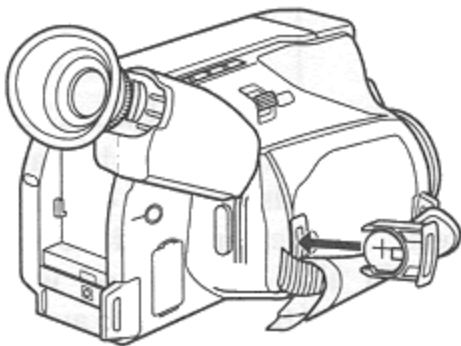

**WARNING: KEEP THE BATTERY AWAY  
FROM CHILDREN AND PETS.**

**IF SWALLOWED  
CONSULT A PHYSICIAN IMMEDIATELY  
FOR EMERGENCY TREATMENT.**

Note: Replace the battery with 3V micro lithium cells such as Maxell CR2025 or its equivalent.

Note: Dispose of battery safely in accordance with local laws. Do not dispose of in fire.

Note: Do not short circuit the battery. Note: Do not take apart the battery.

Note: Do not hold the battery with the metallic tweezers.

Note: Do not recharge the battery. Note: Keep the battery in a dark, cool, dry place.

## Remaining Tape

## Getting Started

The tape remaining display shows the remaining tape that can be used for recording and playback, using seven dashes. This feature is handy when recording since it lets you know how long you can record on the loaded tape.

Insert a cassette into the camcorder and start recording or playback; 10 seconds later, the remaining tape will be displayed. When the cassette is ejected, the display will disappear. " [Tape Icon] -----" is displayed for 10 seconds after the tape starts to run.

**Note:** The tape remaining display appears 10 seconds after the tape starts to run.

**Note:** When the remaining tape time becomes less than about three minutes, "TAPE END" flashes in the viewfinder or on the LCD monitor.



## Using the Linear Time Counter

The linear time counter displays the tape run in hours, minutes, and seconds, helping you to keep track of how long you've been filming or time you have left to film before running out of tape.

Turn the camcorder on to display the linear time counter. The linear time counter keeps track from when you load a cassette into the camcorder and clears to "0:00:00" when the cassette is ejected.



## Display in Viewfinder or on LCD Monitor

When you are using the camcorder, the selected functions and time counter will appear in the viewfinder or on the LCD monitor. If the characters and icons displayed during recording and playback bother you, press the DATE/DISP. button on the camcorder to erase them.



- Even if the shutter speed (AE:250, etc.), "ZOOM", image stabilizer icon, etc. are being displayed, only the title and date/time will be recorded on tape.



- If the time counter, etc. is displayed during playback, it will also appear on the connected TV screen. If the tape is dubbed as is, the counter will also be recorded with dubbed image: Switch off the display to avoid this.

## Switching the Display

**CAM mode:** Press the DATE/DISP. button on the camcorder to switch the display.

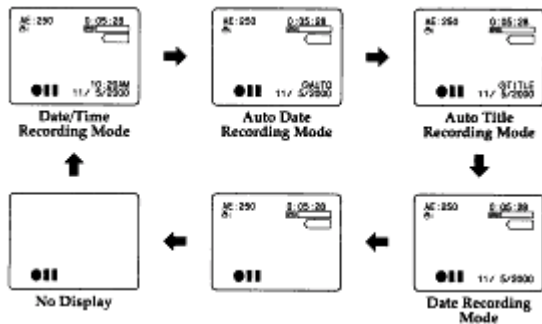

**VIDEO mode:** Press the DATE/ DISP. button on the camcorder or DISPLAY AY button on the remote control to switch the display.

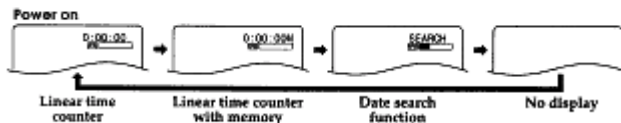

- When a recorded tape is in the camcorder during the VIDEO mode, "SEARCH" appears in the viewfinder or on the LCD monitor. (See "Date Search" on page 51.)
- See "Using Memory" on page 51.

**Note:** The linear time counter with the memory feature and "SEARCH" in the viewfinder or on the LCD monitor can also be displayed on the connected television.

**Note:** If the LCD monitor is opened or closed (the picture is switched) during playback, the on-screen display in the picture will disappear for about one second, and then reappear again.

## Setting the Date and Time

Take the time to set the date and time now. The date and time can be recorded on your tapes to act as a handy reference when viewing them later. Use the following procedure to set up the display for the current date and time,

**Note:** Be sure to insert the clock battery before setting the date and time. Although the date and time can be set without the clock battery inserted, they will disappear when the battery providing power to the camcorder is removed.

**Note:** If you leave the powered camcorder for 10 minutes without a cassette inserted when the date has not been set or the clock battery is dead, the camcorder demonstration mode will start. To cancel the demonstration mode, disconnect power from camcorder and reconnect it, or insert a cassette.

Make sure that the current time is displayed correctly before you start filming.

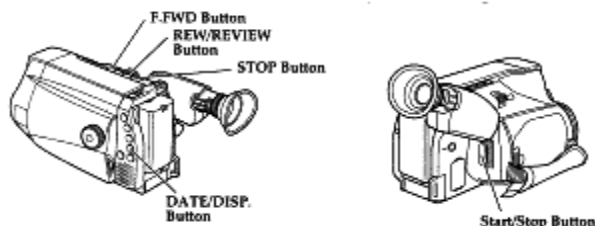

1 Load the battery. ("Camcorder Power Sources", p17.)

## Basic Techniques

2 Press the red button on the CAM/OFF/VIDEO switch as you slide it to CAM.

3 Press the DATE/DISP. button and look into the viewfinder or LCD monitor. The date and time should appear in the lower right with the " 1" flashing.

12:00 AM  
1/ 1/1999

4 Pressing the F.FWD button gives you higher numbers while the REW/REVIEW button gives you lower numbers. Select the right month and Press STOP button. Use the F.FWD, REW/REVIEW and STOP buttons to select the proper day, year, hour, minute, and AM or PM

12:00 AM  
11/ 5/1999

5 After setting the AM/PM, press the DATE/DISP. button. The display changes and the internal clock starts.

6:30 AM  
11/ 51/2000

**Note:** After the date and time are set, " AUTO" appears and the camcorder enters the automatic date recording mode. See 'Date Recording" on page 38.

### Correcting the Date and Time

1 Press the DATE/DISP. button while pressing the STOP button. The flashing cursor appears at the month.

2 Move to where you need to make the correction with the STOP button and use the F.FWD and REW/REVIEW to correct.

3 Press the DATE/DISP. button to set the corrected date and time.

## Basic Techniques

*The batteries are in place and charged, the date and time are set and you are familiar with the controls its time to make a recording. Basic recording is easy and simple. Hooking up the camcorder to your TV is not complicated but give yourself plenty of time to ensure connections ore correct,*

*This section guides you through basic recording and playback. Practice the basic techniques of recording and playback on something unimportant such as traffic or a short tour of your backyard. Once familiar with how the machine works you can move to the more sophisticated features with less stress.*

*Let's get started!*

---

## Making a Basic Recording

*The Hitachi VM-E455LA/VM-H655LA uses PROGRAM AE auto exposure that automatically selects the optimum shutter speed (either 1/60, 1/120, 1/180, 1/250, 1/350, 1/500, 1/750, 1/1000, 1/1500, 1/2000, or 1/4000 of a second). The iris adjusts automatically in response to the shutter speed.*

## Basic Techniques

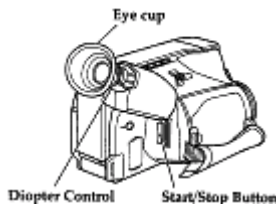

1 Connect the camcorder to a power source (See pages p16 - p17).

2 Open the LCD monitor and insert a cassette ("Inserting and Removing Cassettes", p20).

If you want to view the picture being recorded on the LCD monitor, leave the monitor open. If you want to view the picture in the viewfinder, close the LCD monitor.

**Note:** Pull out the eye cup all the way when using the viewfinder.

3 Press the red button on the CAM/OFF/VIDEO switch as you slide it to CAM. The lens door

will open automatically. "●||" appears in the viewfinder or on the LCD monitor and the camcorder is now ready to record.

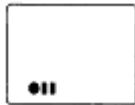

4 When you are ready to record press the Start/ Stop button. "REC" appears and the camcorder records the picture you see in the viewfinder or on the LCD monitor.



5 To stop recording press the Start/Stop button and "REC" disappears from the viewfinder or LCD monitor replaced by "●||". This places the camcorder in standby.

6 After recording, slide the CAM/OFF/VIDEO switch to OFF position to turn off the camcorder.

**Note:** If the LCD monitor is opened or closed (the monitor picture is switched between the viewfinder and LCD monitor) during recording, the on-screen display will disappear for about one second. It is recommended that you do not switch the picture during recording as the date or title superimposed in the picture being recorded will disappear for about one second.

**Note:** If the LCD monitor is opened or closed during recording, several white stripes may appear in the picture, but this does not indicate a fault. However, these stripes are recorded with the picture, so it is recommended that you do not close or open the LCD monitor during recording.

**Note:** "TAPE" flashes in the viewfinder or on the LCD monitor when the tab on the side of the cassette is completely visible.

**Note:** "TAPE END" flashes in the viewfinder on the LCD monitor when about 3 minutes or less remain of the tape cassette.

**Note:** If the camcorder is left in record/ pause mode for more than 5 minutes, the camcorder turns off automatically. To restart it press the Start/Stop button and the camera returns to record/pause mode.

---

## Using Instant Review

Use this feature to view the last few seconds of the tape you shot.

1 Set the camcorder to record/pause mode and tap the REW /REVIEW button. The last few seconds of the tape playback in reverse and then in normal playback mode.

**Note:** Sound is heard from the speaker during normal playback.

2 The camera plays back to the spot where you paused and returns to record/pause mode (standby). Press the Start/Stop button to resume recording.



---

## Using Auto Focus

The camcorder focuses the subject in the center of the viewfinder or LCD monitor automatically unless the manual focus is engaged. If "FOCUS" appears in the viewfinder or on the LCD monitor, manual focus is engaged. Press the FOCUS/ VOL. control buttons simultaneously to return to auto focus.



The auto focus will not work under the following conditions and you must focus manually:

Objects outside the center of the viewfinder or LCD monitor



Objects at different distances in the center of the view finder or LCD monitor



Brightly lit objects such as a neon light, objects lit by spotlight, etc.

## Basic Techniques



Objects behind water dappled or dusty glass



Objects with little difference in light reflection such as a white wall

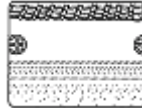

Rapidly moving objects



Dark objects



**Note:** With the T zoom control you can use the auto focus with subjects that are 3.3 feet (100 cm) away from the lens and further away to infinity. With the W zoom control you can use the auto focus with subjects 3/8 inches (1 cm) away from the lens and further away to infinity.

---

## Using Manual Focus

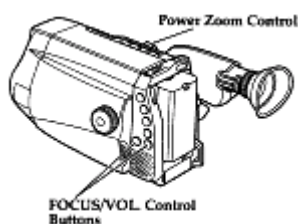

- 1 Press the FOCUS/VOL. control buttons simultaneously. "FOCUS" displays in the viewfinder or on the LCD monitor. You can adjust the focus manually.
- 2 Use the power zoom T control to zoom up completely to your subject. If you don't use the T control to zoom to the picture you want, the picture may fall out of focus when actual recording starts.
- 3 Press the FOCUS/VOL. control ▲ (far) or ▼ (near) button until the subject is in focus.
- 4 Use the power zoom W control to zoom back to the picture you desire.

**Note:** To return to auto focus press the FOCUS/ VOL. control buttons and the "FOCUS" disappears from the viewfinder or LCD monitor.

---

## Using the Power Zoom

## Basic Techniques

The power zoom *W* control widens the picture, moving the subject farther away, while the power zoom *T* control brings the subject closer, narrowing the picture. If "ZOOM" appears at the left of the viewfinder or LCD monitor, the digital zoom function shown below has been engaged.

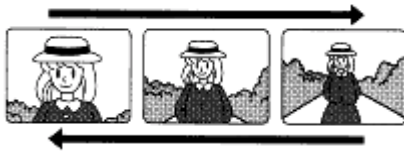

The zoom speed varies depending on how the power zoom control lever is moved: the more the lever is moved, the higher the zoom speed will be.

When the power zoom control is operated, the zoom position is displayed in the viewfinder or on the LCD monitor for about 5 seconds and then disappears. The zoom position is displayed in 10 steps.



## Using the Digital Zoom

The digital zoom increases the magnification of the power zoom by 4.5 times. You must place the subject you wish to magnify at the center of the viewfinder or LCD monitor.



Slide and hold the power zoom control to the "T" side until you find the picture you want. You control the zoom with the power zoom T and W controls. When "ZOOM" is not displayed in the viewfinder or on the LCD monitor, normal zoom functions resume.

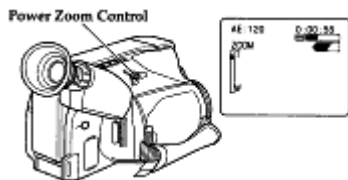

**Note:** This digital zoom has certain limitations and may degrade at extreme magnification and amplify camcorder's movement.

## Using the INST. ZOOM (instant Zoom) Button

The instant zoom feature activates the digital zoom to magnify the subject 7.5 times regardless of zooming engaged by the power zoom T and W controls.

Press the INST. ZOOM button. "I. ZOOM" appears at the left of the viewfinder or LCD monitor and the picture is magnified 1.5 times.



## Basic Techniques

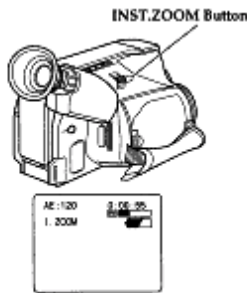

**Note:** To return to the original zoom position, press the INST. ZOOM button so that "I. ZOOM" disappears from the viewfinder or LCD monitor. **Note:** This instant zoom has certain limitations and may degrade at extreme magnification and amplify camcorder's movement.

## Using Macro

This function allows you to shoot subjects as close as 3/8 inches (1cm). Press and hold the power zoom control W. The camera focuses on the subject automatically. Check your lighting as it tends to be insufficient when filming close up.



## Playback

You can view recorded pictures on the LCD monitor immediately after recording.

**Note:** Make sure that "PAL60" does not appear in the viewfinder or on the LCD monitor: If it is displayed, no color will appear in the played back picture

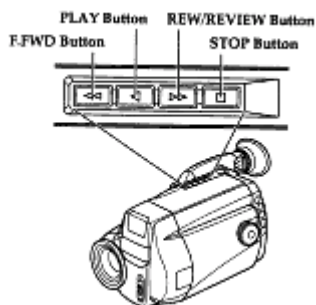

- 1 Open the LCD monitor, and then adjust the angle of the monitor ("Opening the LCD Monitor", p19).
- 2 Hold down the red button on the CAM/ OFF/ VIDEO switch while sliding the switch to VIDEO.
- 3 Press the REW/REVIEW button to rewind the tape. For fast forwarding the tape, press F.FWD.
- 4 Press the PLAY button and play back the tape. To adjust the volume, press the FOCUS/VOL control buttons. When either button is pressed, the volume adjustment display will appear on the LCD monitor for about 5 seconds. Press ▲ to increase the volume, or press ▼ to decrease it. After 5 seconds, the adjustment display

## Basic Techniques

will automatically disappear.

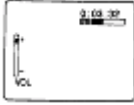

5 Press the STOP button when you have finished.

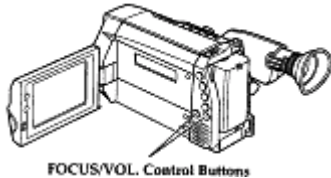

**Note:** Decrease the sound volume of the camcorder when you play back a recording by connecting the camcorder to your TV. If the volume of the camcorder is set to maximum, the played back picture may be distorted. Make sure that the volume is not set to maximum during recording as it could distort the played back picture.

**Note:** When the LCD monitor is turned on and left as it is, the monitor becomes warm, but this does not indicate a fault.

**Note:** When the CAM/OFF/VIDEO switch is set to CAM or VIDEO, the LCD monitor is turned on and off automatically when the LCD monitor is opened and closed.

**Note:** It is recommended that you close the LCD monitor to save the battery power when playing back a picture on a TV without viewing it.

**Note:** Only the playback sound is heard. The sound being recorded is not heard.

**Note:** No sound is heard when the LCD monitor is closed.

## To Play Back a Tape with the Viewfinder

Close the LCD monitor, then press the PLAY button to play back the tape. The picture appears in the viewfinder.

**Note:** You cannot hear the playback sound when playing back your video with the viewfinder.

## Using Still

To view a still picture during playback press the Start/Stop. Press the Start/Stop button again to resume playback. If you leave the camcorder in play/pause mode for more than 5 minutes the camcorder automatically stops the cassette to prevent damage to the tape. You can view a still picture with less noise on the LCD monitor (Clear still).



**Note:** The still picture will have several noise bars in the viewfinder and on the TV, but this does not indicate a fault.



**Note:** If you are freezing a picture with the LCD monitor closed, then you will not be able to view a still picture with

less noise when you open the monitor.

## Using Forward and Reverse Search

When looking for a particular point in your videotape use the F.FWD button and REW/REVIEW button to find the spot quickly.

### When the LCD monitor is closed:

- Press the F.FWD button during playback to play the tape forward at approximately 9 times normal speed. Press the PLAY button to return to normal playback.
- Press and hold the F.FWD button during fast forward to visually scan the tape at 19 times the normal playback speed. Releasing F.FWD returns the camcorder to fast forward.
- Press the REW/REVIEW button during playback to play the tape backwards at approximately 7 times normal speed. Press the PLAY button to return to normal playback.
- Press and hold the REW/REVIEW button during fast rewind to visually scan the tape backwards at 17 times the normal playback speed. Releasing REW/REVIEW returns the camcorder to fast rewind.

**Note:** When you engage F.FWD button or REW/REVIEW button the picture will have some interference or noise in the viewfinder. This is normal during search mode.



### When the LCD monitor is open (Clear Search):

You can view pictures with less noise on the LCD monitor during forward or reverse search.

- Press the F.FWD button during playback to play the tape forward at 6 times normal play speed. Press the PLAY button to resume normal playback.
- Press and hold the F.FWD button during fast forward to visually scan the tape at 17 times the normal playback speed., Releasing F.FWD returns the camcorder to fast forward.
- Press the REW/REVIEW button during playback to play the tape in reverse at 4 times normal speed. Press the PLAY button to resume normal playback.
- Press and hold the REW/REVIEW button during fast rewind to visually scan the tape backwards at 15 times the normal playback speed. Releasing REW/REVIEW returns the camcorder to fast rewind.

**Note:** If you are using forward or reverse search with the LCD monitor closed, then you will not be able to view pictures with less noise when you open the monitor,

**Note:** Several noise bars will appear on the TV screen during forward or reverse search.

**Note:** A noiseless picture will not appear during high-speed search even if the LCD monitor is open,

**Note:** Noise may flow during high-speed search in low temperature conditions.

---

## Playing Back Your Recording on Your TV

*Depending on the setup of your video equipment, you connect the camcorder in one of the 3 methods explained below.*

### Connecting to a Television with a VCR Attached

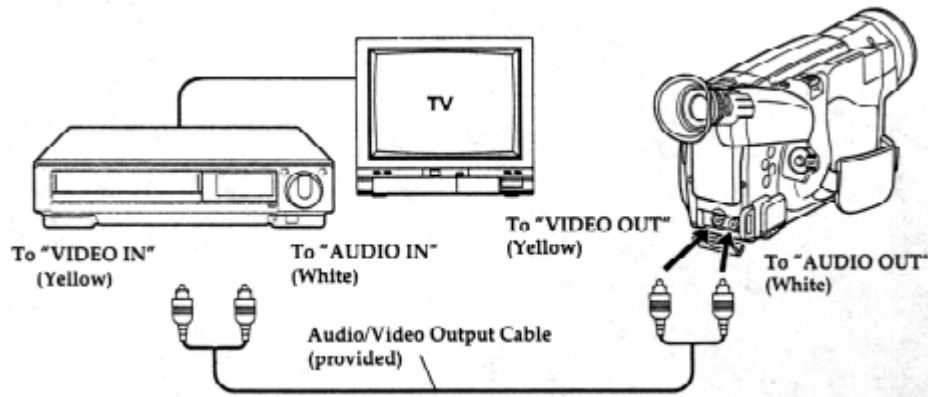

1. Connect the provided audio/video output cable to the AUDIO IN and VIDEO IN jacks of your VCR.

**Note:** If your VCR has two (stereo) AUDIO IN jacks, connect the audio plug to the left-channel AUDIO IN jack.

2. Connect the other ends of the cable to the AUDIO OUT and VIDEO OUT jacks of the camcorder.

3. Insert a previously recorded cassette into the camcorder.

4. Turn on your VCR and place it in the camcorder input mode (consult your VCR manual for details). Operate the television as you normally do to see the signal coming from the VCR.

5. Hold down the red button on the CAM/OFF/VIDEO switch while sliding the switch to VIDEO.

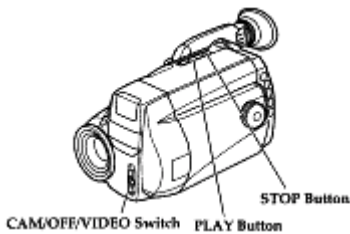

6. Press the PLAY button to begin playback.

7. Press the STOP button when finished.

## Connecting to a Television with Audio In and Video In Jacks

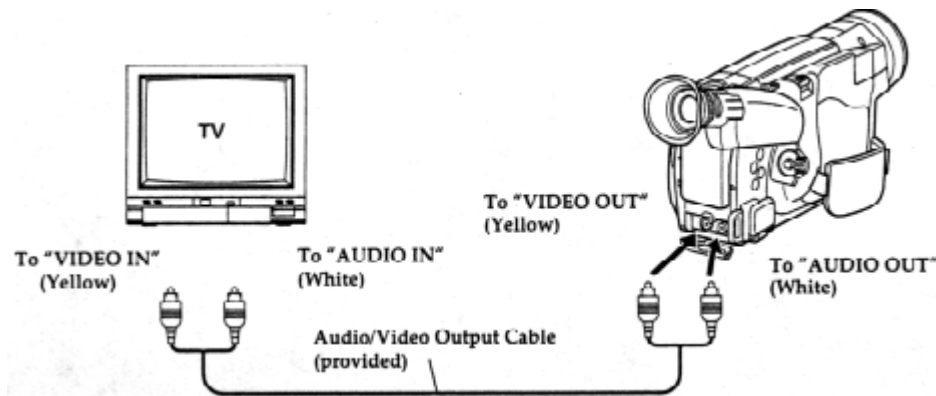

1. Connect the provided audio/video output cable to the AUDIO IN and VIDEO IN jacks of your television.

**Note:** If your television has two (stereo) AUDIO IN jacks, connect the audio plug to the left-channel AUDIO IN jack.

2. Connect the other ends of the cable to the AUDIO OUT and VIDEO OUT jacks of the camcorder.
3. Insert a previously recorded cassette into the camcorder.
4. Turn on your television and set to the camcorder input mode (consult your television manual for details).
5. Hold down the red button on the CAM/OFF/VIDEO switch while sliding the switch to VIDEO.

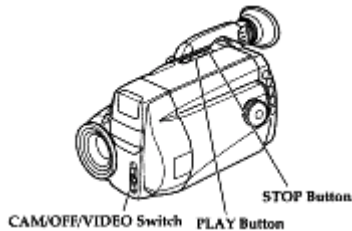

6. Press the PLAY button to begin playback.
7. Press the STOP button when finished.

## Connecting to a Television without Audio In and Video In Jacks

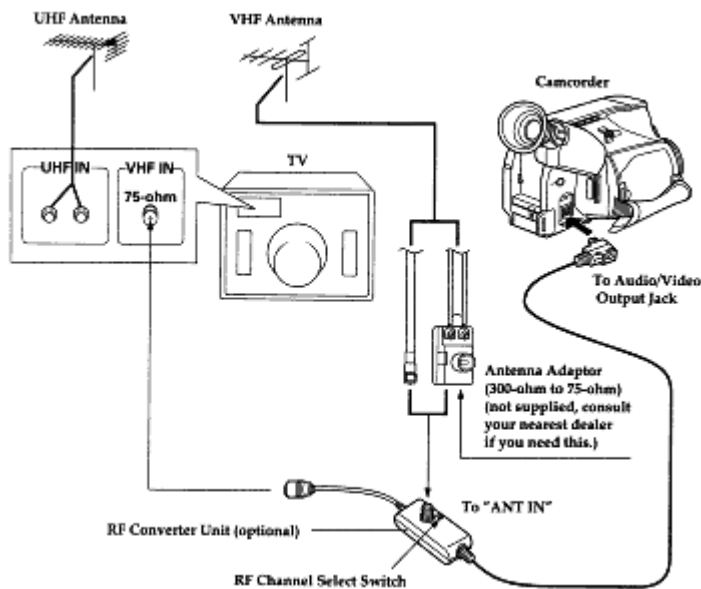

1. Disconnect the VHF antenna leads from the back of the television. Leave the UHF antenna leads connected.
2. Connect the VHF antenna lead to ANT IN of the RF output adapter. If the cable on the VHF antenna lead is flat you need to purchase an antenna adapter (300-ohm to 75-ohm transformer). Connect the antenna adapter to the VHF antenna lead and slide the adapter on to the ANT IN terminal.
3. Connect the 75-ohm coaxial cable of the RF output adapter to the VHF antenna terminals on the back of the television. If the television is set up to connect to a flat antenna lead you need to purchase antenna adapter (75-ohm to 300-ohm transformer). Connect the adapter to the 75-ohm coaxial cable of the RF output adapter and connect the free ends of the adapter to the VHF antenna terminals at the back of your television.

## Basic Techniques

4. Connect the RF output adapter cable to the Audio/Video Output jack of your camcorder.
5. Turn your television on and select channel 3 (channel 4 if channel 3 is a channel used in your area).
6. Select the CH3 or CH4 on the RF output adapter matching the channel selected on your television.
7. Insert the previously recorded cassette into the camcorder.
8. Hold down the red button on the CAM/OFF/VIDEO switch while sliding the switch to VIDEO.
9. Press the PLAY button to begin playback.
10. Press the STOP button when finished.

**Note:** The RF converter unit cannot be used during multi playback (PAL60 output).

## Video Effects in Playback Mode

The digital signal processor (DSP) in this camcorder allows you to add special effects to playback Pictures. Use this feature during tape dubbing, etc. to create a tape with a more artistic impression. The video effect modes during playback include 16x9, Art and Sepia.

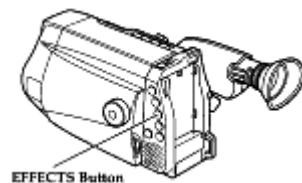

- Each time the EFFECTS button is pressed in the playback or play/pause mode, the playback mode will switch as follows:

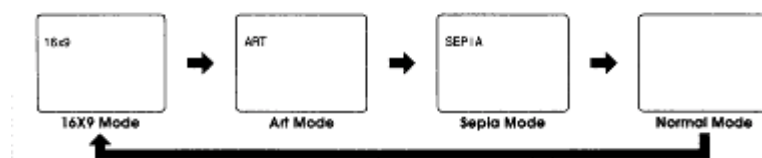

## Activating Video Effects Playback

- 1 Press the red button on the CAM/OFF/VIDEO switch as you slide it to VIDEO.
- 2 Play the tape or set the camcorder to the play/pause mode.
- 3 Press the EFFECTS button to select the video effect playback mode.

### "16x9": 16x9 Mode

The top and bottom of the picture will be black bars.

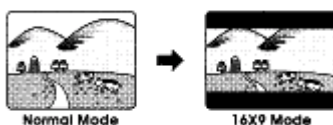

### "ART": Art Mode

The entire picture will take on the look of an oil painting.

## Basic Techniques

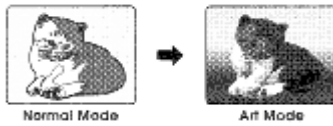

### "SEPIA": Sepia Mode

The entire picture will be sepia.

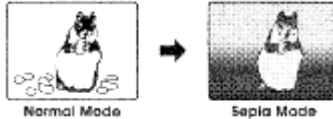

**Note:** To switch the mode of return to the normal picture during tape dubbing, temporarily stop the dubbing and press the EFFECTS button.

**Note:** When tape stops, the normal picture will be restored.

## Multi Playback

This camcorder can convert on NTSC recorded tape into "PAL60" format signal. "PAL60" is a special output signal format with which a PAL TV can be used to view a tape recorded on on NTSC recorder.

### Connecting to a PAL Television

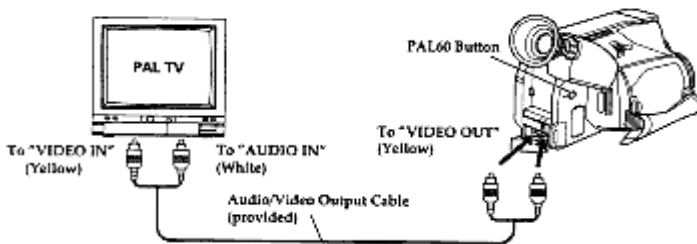

- 1 Connect the camcorder to TV as shown in the figure.
- 2 Turn the TV on and select the TV "video input". Set the TV to the PAL60 mode.
- 3 Set the CAM/OFF/VIDEO switch of the camcorder to VIDEO.
- 4 Press the PAL60 button.
- 5 Press the PLAY button of the camcorder. If you press the DATE/DISP. button at this time, "PAL60" will appear in the viewfinder or on the LCD monitor.



- 6 When playback is finished, set the CAM/OFF/ VIDEO switch to OFF position.

**Note:** Connect the camcorder to a TV monitor which has a vertical sync adjustment circuitry (volume) for 60 Hz and which can also be locked into the PAL60 mode. Refer to the TV instruction manual for details on how to set the TV.

**Note:** This camcorder cannot record using the PAL60 system.

**Note:** A black-and-white picture will appear on the LCD monitor when playing back tape with the PAL60 system.

**Note:** The PAL60 button is effective during playback only.

**Note:** Depending on the state of the tape recorded, the PAL60 button may not operate normally.

**Note:** The RF converter unit cannot be used during multi playback (PAL60 output).

**Note:** The PAL60 mode will be released when the camcorder is turned off.

## Advanced Techniques

### Advanced Techniques

*The Hitachi VM-E455LA/VM-H655LA offers a diverse group of features that add interest and excitement to your video. A doing fades to smooth transitions creates video with a professional look.*

*As you learn and practice with these features think of situations that they might fit in and odd a special touch.*

### Date Recording

*When the date has been set, the camcorder will enter the automatic date recording mode automatically*



1 Press the red button on the CAM/OFF/ VIDEO switch as you slide it to CAM.

2 Press the DATE/DISP. button to specify the date display you want to record.

#### " AUTO" and Date - Automatic Date Recording

This option records the date automatically once a day at the beginning of recording for 10 seconds.

AUTO  
11/ 5/2000

**Note:** The camcorder records the same date when:

- the cassette is replaced.
- you select " AUTO" and date display again.
- the recording is less than 10 seconds long.

**Note:** if the date changes while recording continues over 10 seconds, the new date is recorded for about 10 seconds the next time you make a recording.

#### " TITLE" and Date -Automatic Title and Date Recording

This option records the date and selected title or created title (see "Creating and Recording a Title", p52) automatically once a day at the beginning of recording for 10 seconds.

HAPPY BIRTHDAY  
TITLE  
11/ 5/2000



## Advanced Techniques

**Note:** When " TITLE" is displayed in the viewfinder of on the LCD monitor, the title cannot be turned on or off using the remote control.

### Date - Date Recording

The camcorder records the date with the picture all the time.



### No Display - No Date Recording

The camcorder does not record the date.



### Date and Time - Date and Time Recording

The camcorder records the date and time with the picture all the time.



3 Press the Start/ Stop button.  
Recording will start.

**Note:** When " AUTO" and date display is selected, the date disappears about 10 seconds after recording is started.

**Note:** When " TITLE" and date display is selected, the title and date disappear about 10 seconds after recording is started.

---

## Creating and Recording a Title

*The titling function allows you to select one of nine titles stored in camcorder memory, or create a new title, and record it. You can choose from three languages to display the stored titles: English, French and Spanish. Select*

or create a title and personalize your recordings, while at the same time keeping a permanent visual record of what is contained on a tape.

The selected or created title can be recorded with the date automatically.

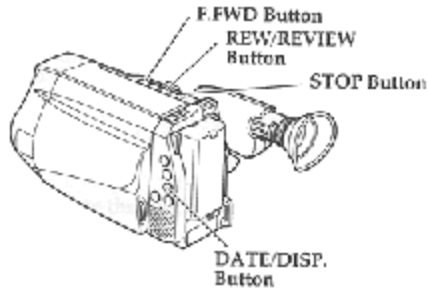

## Selecting Stored Title (Prememo)

**Note:** Be sure to insert the clock battery before selecting a title, Although a title can be chosen without the clock battery inserted, it will disappear when the battery providing power to the camcorder is removed.

1 Connect the camcorder to a power source.

2 Hold down the red button on the CAM/OFF/ VIDEO switch and slide it to either CAM or VIDEO.

3 Press the TITLE ON/OFF button on the remote control.

A flashing cursor will appear in the viewfinder or on the LCD monitor, and the camcorder will enter the title creating mode ("Creating a Title" on next page).



4 Press the PLAY button.

"HAPPY BIRTHDAY" will appear.



You can choose the desired language of the displayed title by pressing the PLAY button, as in the following order:



English  
↑

French  
↓

---



---

**Title creation mode**

**Spanish**

5 Use the F.FWD or REW button to select a desired title.



**Stored titles (Prememo) available**

**<English>**

HAPPY BIRTHDAY  
MERRY CHRISTMAS  
CONGRATULATIONS  
THE SUPERSTAR  
VACATION FUN  
THANKSGIVING  
HAPPY EASTER  
ANNIVERSARY  
HAPPY NEW YEAR

**<French>**

BON ANNIVERSAIRE  
JOYEUX NOEL  
FELICITATIONS  
"SUPERSTAR"  
VACANCES  
"THANKSGIVING"  
JOYEUSES PAQUES  
ANNIVERSAIRE  
BONNE ANNEE

**<Spanish>**

FELIZ CUMPLEAÑOS  
FELICIDADES  
EL PROTAGONISTA  
FELIZ NAVIDAD  
VACACIONES  
ANIVERSARIO

FELIZ AÑO NUEVO  
SEMANA SANTA  
FIESTA

6 After you have selected the title, press the TITLE ON/OFF button. The selected title will be stored in memory and then disappear.

## Creating a Title

A title contains two lines of up to 16 characters per line. The camcorder contains 79 different characters for creating a title.

**Note:** Be sure to insert the clock battery before creating a title. Although a title can be created without the clock battery inserted, it will disappear when the battery providing power to the camcorder is removed.

- 1 Connect the camcorder to a power source.
- 2 Hold down the red button on the CAM/ OFF/VIDEO switch and slide it to either CAM or VIDEO.
- 3 Press the TITLE ON/OFF button on the remote control and a flashing cursor appears in the viewfinder or on the LCD monitor.

**Note:** If a stored title appears, press the PLAY button to display the screen for creating a title.

TITLE  
11/ 5/2000

- 4 Use the STOP button to place the cursor where you wish to begin your title.
- 5 Use the F.FWD and REW buttons to select the first character of your title.

## Advanced Techniques

TITLE  
11/ 5/2000

6 Once you've selected a character press the STOP button to set it.

J  
  
TITLE  
11/ 5/2000

7 Complete the title by repeating steps 5 and 6.

JANE'S BIRTHDAY  
  
TITLE  
11/ 5/2000

8 When you complete your title, press the TITLE ON/OFF button on the remote control to store the title in memory and remove the title graphics from the viewfinder or on the LCD monitor.

**Note:** As long as the correct current time can be displayed, the title is held in memory.

### Characters available for your title



### Correcting Errors

1 Set the CAM/OFF/VIDEO switch to CAM.

2 Repeatedly press the DATE/DISP. button until the title graphics appears.

## Advanced Techniques

- 3 Use the STOP button to select the character to be corrected.
- 4 Use the F.FWD and REW/REVIEW buttons to correct the character.
- 5 Repeatedly press the DATE/DISP. button to store the corrected title in memory.

## Digital Effects Recording

The digital processor in this camcorder allows you to record the picture and add special effects; 16x9 recording mode, a negative image (negative/positive recording), 300 times digital zoom feature (with instant zoom), a symmetric image, obtained by placing a mirror at the center of the screen (half-mirror recording), and an image in mosaic (mosaic recording), and an oil painting look (art mode)..

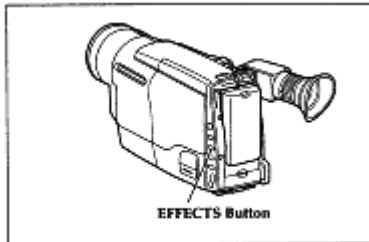

**Note:** The half-mirror recording and mosaic recording functions cannot be used with digital zoom, instant zoom, image stabilizer or zoom fade function.

- Each time the D.EFFECT button is pressed, the recording mode is switched.

16x9

**16X9 Mode**

NEGPOS

**Negative/Positive Mode**

ZM:2

**X400 Digital Zoom Mode**

MIRROR

**Half-Mirror Mode**

MOSAIC

**Mosaic Mode**

ART

**Art Mode**

**Normal Mode**

## Activating Digital Effects Recording

1. Place the camcorder in the record pause mode.
2. Press the EFFECTS button to select the digital effects mode you want.

## 16x9: 16x9 Mode

The picture format can be switched from the 4:3 (the picture format of an ordinary TV set) to 16x9. The top and bottom of the picture in the viewfinder become black bars.

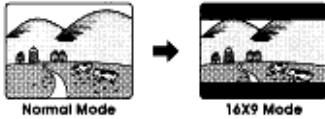

## NEGPOS: Negative/Positive Mode

The image in the viewfinder or on the LCD monitor will become negative.

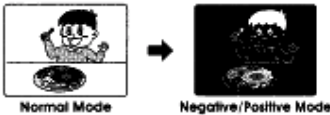

## ZM:2: x400 Digital Zoom Mode

Slide and hold the power zoom control to the "T" side until you reach your desired magnification.



- This function can magnify an image up to 300 times when instant zoom is used at the same time.

## MIRROR: Half-Mirror Mode

The image in the viewfinder will change to a symmetric image on the left and right, obtained by placing a mirror at the center of the screen.

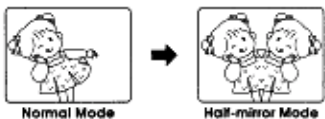

**Note:** This function cannot be used with digital zoom, instant zoom, image stabilizer or zoom fade function.

**Note:** The subject image will be compressed in the horizontal direction and narrow slightly.

## MOSAIC: Mosaic Mode

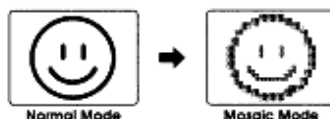

The image in the viewfinder or on the LCD monitor will be in mosaic.

**Note:** This function cannot be used with digital zoom, instant zoom function.

**Note:** The subject image will be compressed in the horizontal direction and narrow slightly.

## "ART": Art Mode



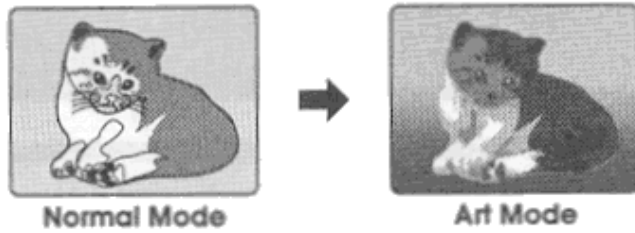

3. Press the Start/Stop button to start recording.
  - To release digital effects mode, repeatedly press the EFFECTS button in record pause mode until the normal mode is restored.

## Using Digital Fade

Use the fade feature to add a professional touch to your recordings. Use the FADE button to select one of the four fade options.

**Note:** If you press the EFFECTS button after setting the fade function, the fade function will be released. After setting the digital effect mode, reset the fade function.

- **White fade:** Fades in from a white screen or fades out to a white screen. "  " appears in the upper left corner of the viewfinder.

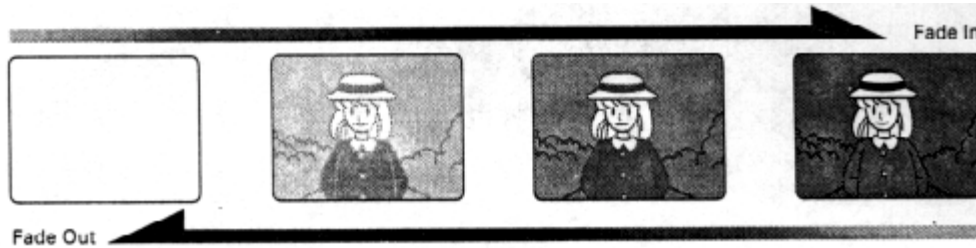

- **Wipe fade:** The picture opens gradually from the center of a black screen or closes into the center to a black screen. "  " appears in the upper left corner of the viewfinder.

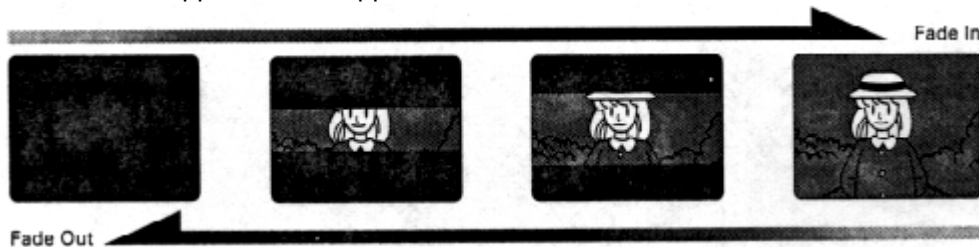

- **Mosaic fade:** Fades in from a picture in mosaic or fades out to a picture in mosaic. "MOS.F" appears in the upper left corner of the viewfinder or LCD monitor

**Note:** The subject image, immediately before fading in or out, will be compressed in the horizontal direction and narrow.

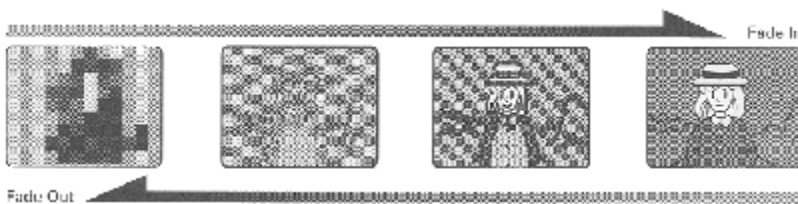

## Advanced Techniques

- **Art fade:** Fades in from, or fades out to a picture with the feel of an oil painting. "ART.F" appears in the upper left corner of the view finder of LCD monitor.

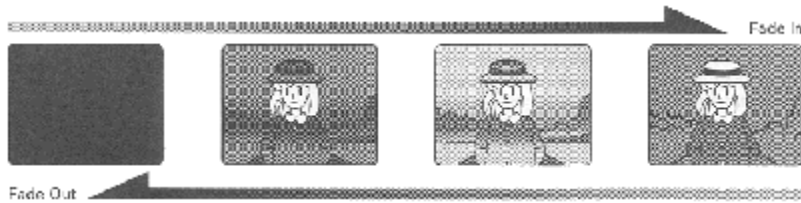

- **Zoom fade:** Fades in while zooming from a white screen or fades out while zooming to a white screen. "Z" appears in the upper left corner of the viewfinder.

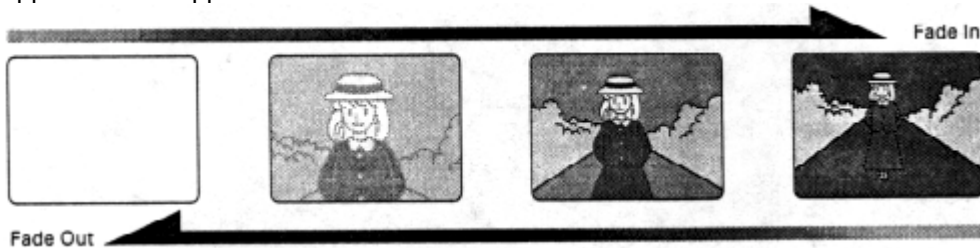

- **Black-and-White fade:** fades in from a black-and-white screen or fades out to a black-and-white screen. "B/W" appears in the upper left corner of the viewfinder.

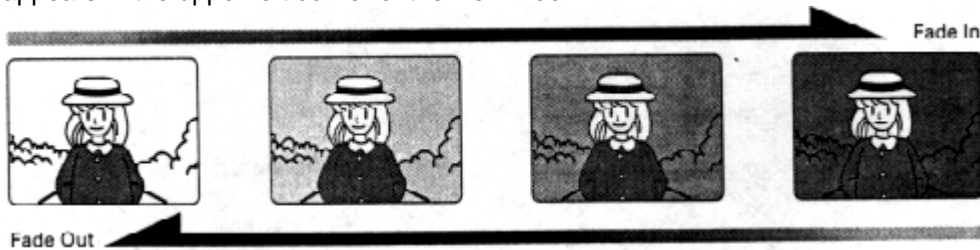

## Fading In

1. Use the FADE button to select a fade option before recording.
2. Press the Start/Stop button to start recording; fade begins automatically.

## Fading Out

1. While recording with the camcorder use the FADE button to select a fade option.
2. Press the Start/Stop button to stop recording; the fade begins automatically and "REC" flashes until the fade ends.

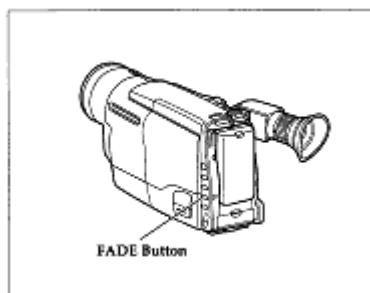

**Note:** When fading out be sure to wait until the PAUSE indicator (  ) is visible in the viewfinder before

attempting to put the camcorder into the record mode again.

---

## Date Search

*The date search function memorizes the start and end positions of recordings you made on a specific day so you can easily locate those positions later as long as the cassette is left in the camcorder.*

**Note:** Be sure that the date and time are set.

1. Attach a power source and slide the CAM/OFF/VIDEO switch to VIDEO.
2. Press the DATE/DISP. button to display "SEARCH" in the viewfinder or on the LDC monitor.



3. Press the REW/REVIEW button to search for the start position from which you last made a recording or the F.FWD button to recording end position. "◀ SEARCH" will appear while the start position is being searched for; "SEARCH ▶", while the end position is being searched for.

4. When the required position is located, the camcorder enters the stop mode and "SEARCH" disappears from the viewfinder or on the LDC monitor.

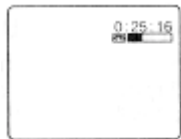

**Note:** If you have ejected the cassette, this function will not operate with that cassette. (When a cassette is inserted and the recording is started, the position is identified as the recording start position on that day.)

**Note:** If the clock battery is not inserted, the date search function does not operate when the battery providing the power to the camcorder is removed.

**Note:** When the cassette was recorded by another camcorder, the date search function does not operate.

**Note:** The date search function is released when you press the STOP button during date search mode.

**Note:** If the recorded time is less than 30 seconds, the date search function may not operate normally.

---

## Using Memory

*The linear time counter memory stops a rewinding tape at approximately 0:00:00M. Activate the counter memory when you insert a cassette. Since the counter has been reset, you will be able to rewind the tape to that point after recording. This is useful when you want to start recording from the middle of a tape or rewind the tape after playing it back.*

1. Insert a tape. The linear time counter appears.
2. Start recording or playback of a cassette.
3. Press the STOP button to stop playback, or press the start/stop recording and set the CAM/OFF/VIDEO switch to VIDEO.

4. Press the DATE/DISP. button . "M" appears next to the counter.
5. Press the REW/REVIEW button and the tape stops at approximately where you reset the linear time counter. This feature works in F.FWD as well.

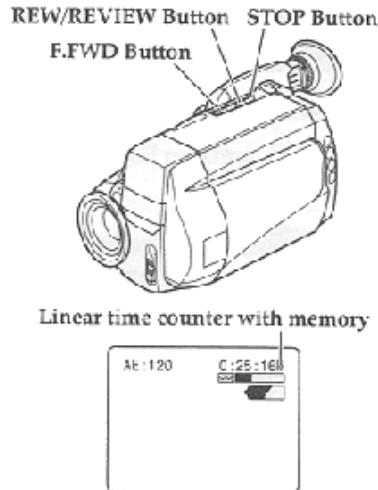

## Using Quick Edit

Use quick edit to search for the end of previously recorded material, find a particular spot on your tape, begin editing, or record new material. While the camera is in record/pause mode hold down the F.FWD, REW/REVIEW, or PLAY button and visually search the tape. Release the button and the camcorder stops the tape at the exact position you selected.

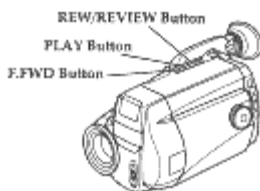

**Note:** If the F.FWD or REW/REVIEW button is pressed for quick edit, noise will appear in the viewfinder, on the LCD monitor, or on the connected TV.

## Attaching the Optional Wide or Tele Converter Lens

Screw the lens into the threads on the camcorder lens assembly.

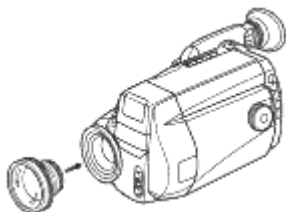

**Note:** If the tele-conversion lens (optional) is attached over the lens, the four corners of the image will be missing in the wide-angle position. Use zoom in the telephoto position.

## Demonstration Mode

*This camcorder is equipped with a demonstration mode. If you leave the powered camcorder for 10 minutes without a cassette inserted when the date has not been set or the clock battery is dead, the camcorder demonstration mode will start.*

### To cancel the demonstration mode

- Disconnect power from camcorder and reconnect it.
- Insert a cassette.

If you do not want the camcorder to enter the demonstration mode, set the date beforehand.

## Dubbing from the Camcorder to a VCR

*Connect the camcorder to a VCR to copy your or a friend's home 8mm recordings to VHS.*

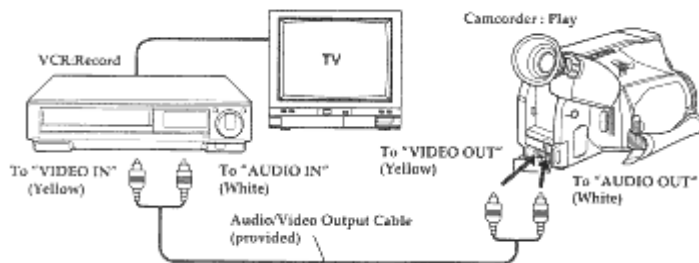

- 1 Connect your camcorder to the VCR, following "Playing Back Your Recording on Your TV" on page 32.
- 2 Turn on your VCR and place it in the camcorder input mode (consult your VCR manual for details). Operate the television as you normally do to see the signal coming from the VCR.
- 3 Hold down the red button of the CAM/ OFF/VIDEO switch while you slide the switch to VIDEO.
- 4 Insert the recorded tape in the camcorder and a blank tape into the VCR. Set the VCR to record.
- 5 Play the tape from the camcorder while recording on the VCR.

**Note:** If the VCR is connected to a television and the VCR/TV selector is set to VCR, you can monitor the tape being dubbed.

**Note:** Reduce the volume of the camcorder as low as possible during dubbing. Otherwise the played back pictures could be distorted.

**Note:** During multi playback (PAL60 output), dubbing may not be possible with some VCRs.

## Simple Programmable Edit (Edit remote control is optional accessory)

*Simple programmable edit allows you to program your camcorder to select the scenes you want to copy from a pre-recorded tape. Use the edit remote control (optional) to easily copy scenes from a recorded tape in the camcorder (playback machine) onto a blank tape in a table-top VCR which handles infrared remote signals (recording machine).*

**Note:** Only the VM-RM20EDA edit remote control (optional) can be used with this camcorder.

**Note:** Some VCRs cannot be operated by the edit remote control (optional).

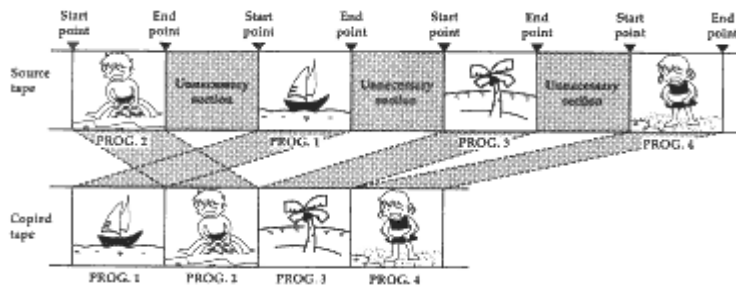

## Programming the Remote Control for the VCR

It is necessary to program the edit remote control to match the VCR before starting editing.

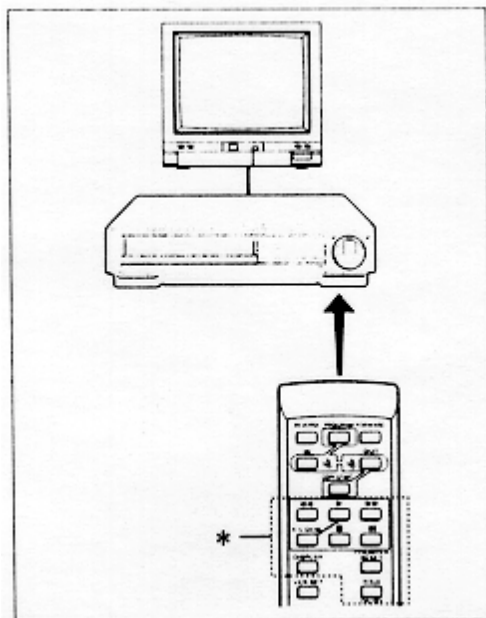

1. Turn the VCR on.
2. Aim the remote control at the infrared receiver on the VCR and press the VCR SET button on the remote control and hold it, then press the button corresponding to the VCR's maker code. For example, if you have a RCA VCR, press the VCR SET button and hold it, then press the DISPLAY button. To check whether the remote control code matches that of your VCR or not, point the remote control at the infrared receiver on the VCR and press the VCR SET button and hold it. If the remote control code has been set, the VCR channel is counted up automatically.

**Note:** If the channel on the VCR does not change with the above operation, you need to switch the remote control code of your VCR. Refer to the VCR's instruction manual. If the channel still does not change after you have changed the VCR's remote control code, the edit remote control cannot operate your VCR.

**Note:** The remote control code is held in memory until it is changed or the batteries are replaced.

**Note:** Use the remote control indoors. When the infrared receivers of the VCR and cam-corder are exposed to direct sunlight or strong artificial light, the remote control may not be operate correctly.

**Note:** The remote control cannot be operated if there is an obstacle between the remote control and infrared receiver. Especially, be careful of this during dubbing.

**Note:** When the edit remote control is connected to the camcorder, the camcorder can be operated with the buttons marked \* in the above figure. See pages 53 and 54 for details.

## Advanced Techniques

Hitachi		REVERSE
Sony		PROGRAM
Panasonic		FORWARD
Toshiba	IN	
Mitsubishi		COPY START
Sanyo		OUT
Sharp		◀◀
NEC		▶
JVC		▶▶
Akai		A/V DUB
Gold Star		■
PHILIPS		
RCA		DISPLAY
Zenith		COUNTER RESET
Magnavox		TITLE ON/OFF

**Note:** The remote control code is held in memory until it is changed or the batteries are replaced.

**Note:** Point the remote control straight at the VCR's infrared receiver for operation.

**Note:** Use the remote control indoors. When the infrared receivers of the VCR and camcorder are exposed to direct sunlight or strong artificial light, the remote control may not operate correctly.

**Note:** The remote control cannot be operated if there is an obstacle between the remote control and infrared receiver. Especially, be careful of this during dubbing.

**Note:** When the edit remote control is connected to the camcorder, the buttons marked \* in the figure above perform the same operations as those of the other remote control provided.

## Operation

You can select up to four different scenes or segments to be copied at one time.

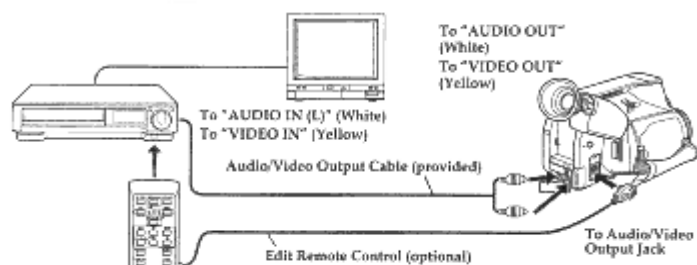

## Advanced Techniques

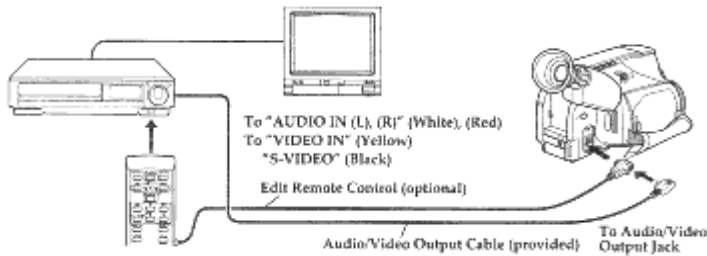

1 Connect the edit remote control to the camcorder, and then connect the audio/video output cable as illustrated above.

**Note:** If your VCR has two (stereo) AUDIO IN jacks, connect the audio plug to the left-channel AUDIO IN jack.

2 Insert a recorded tape into the camcorder.

3 Set the CAM/OFF/VIDEO switch of the camcorder to VIDEO. Turn the recording VCR on and select line input.

4 Press the PROGRAM button of the remote control. The program display appears in the viewfinder or on the LCD monitor.

```

PROG. 1 0: 00 : 02
IN      - : - : -
OUT     - : - : -
    
```

**Note:** If your VCR is connected to a TV, the program display will also appear on the TV screen.

5 Press the button and use the or button to search for the starting point of the segment you want to copy. Press and then to set the camcorder to the play pause mode.

The liner time counter counts when searching for the starting point.



Use the FORWARD and REVERSE buttons in the play or pause mode to fine adjust the tape position. Press FORWARD and hold it; the tape is played while the button is held. Press REVERSE and hold it for reverse play.

6 Press the IN button to store the counter reading. When you press the IN button, OUT flashes in the program display.

```

PROG. 1 0: 15 : 13
IN      0: 15 : 13
OUT     - : - : -
    
```



7 Press the  button to search for the end of the segment you want to copy. Press  and then  to set the camcorder to the play pause mode. Use the FORWARD or REVERSE button as required to fine adjust the tape position.

8 Press the OUT button to store the counter reading at the end of the scene.



9 Continue programming as described above until you have entered up to four different segments.

10 Load a blank tape, then set the VCR to the record pause mode.

11 Point the remote control at the receiver on the VCR and press the COPY START button to start simple programmable edit.

- The camcorder automatically searches for the beginning of the first segment and starts playback. The recording VCR automatically starts recording.
- After recording the first segment, the camcorder automatically searches for the beginning of the next segment and resumes playback. The recording VCR is automatically released from the record pause mode and resumes recording.
- It continues recording and pausing until all the programmed segments are edited.

12 When simple programmable edit is finished, the camcorder will enter the stop mode, and the VCR will enter the record pause mode.

**Note:** If you make a mistake during programming, start again from the beginning or press the COUNTER RESET button to return to the previous steps one by one and enter the correct program data.

**Note:** After the simple programmable edit is finished, the programmed data is erased, if you want to continue editing other segments, repeat steps 5 - 12.

**Note:** Most VCRs (recording machine ) may be released from the record pause mode if it continues for more than five minutes.

**Note:** The dubbing start and end positions may slightly drift from the specified positions when certain VCRs are used.

**Note:** Reduce the volume of the camcorder as low as possible during dubbing, otherwise the played back pictures could be distorted.

### To End Programmable Simple Edit

Press the PROGRAM button to remove the program display from the viewfinder or LCD monitor. Then press the stop button on the recording VCR to set it to the stop mode.

**Note:** If the CAM/OFF/VIDEO switch of the camcorder is set to OFF or CAM when the recording VCR is in the record pause mode, the VCR enters the record mode.

---

## Using the Optional Edit Remote Control

The camcorder can be operated using the buttons on the optional VM-RM20EDA edit remote control which are

marked \* in the figure below.

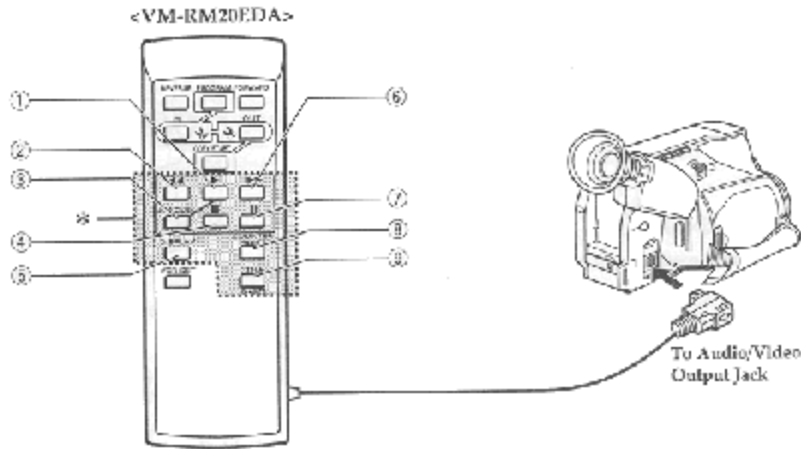

**Note:** The edit remote control cannot be used unless it is connected to the camcorder.

(1) ▶ (Play) Button

Use to playback recorded tape.

(2) ◀◀ (Rewind) Button

Use this button to fast rewind tapes or for visual search.

(3) A/V DUB Button Use this button to record new audio and video over existing audio and video. See "Using Audio /Video Dubbing" on page 54.

(4) ■ (Stop) Button

Use this button to stop playback, fast forward, or rewind.

(5) DISPLAY Button

Use this button to select the viewfinder or LCD monitor and TV display.

(6) ▶▶ (Fast Forward) Button

Use this button to fast forward tapes or for visual search.

(7) || (Pause/Record) Button

In CAM mode, press this button to start recording. When pressed a second time the camcorder pauses. During playback use this button to stop the tape temporarily. Pressing a second time resumes normal playback.

(8) COUNTER RESET Button

Use this button to reset the linear time counter to "0:00:00".

This button can always reset the displayed time to "0:00:00", which is helpful when you are using the counter memory function. See "Using Memory" on page 46.

(9) TITLE ON/OFF Button

Use this button to create or record a title.

If you press this button during playback and recording, the selected or created title will appear. Pressing the button again switches off the title.

---

## Using Audio/ Video Dubbing

Use audio/video dubbing to record audio and video from the camcorder's built-in microphone and camera onto a

## General Maintenance

previously recorded tape in the camcorder.

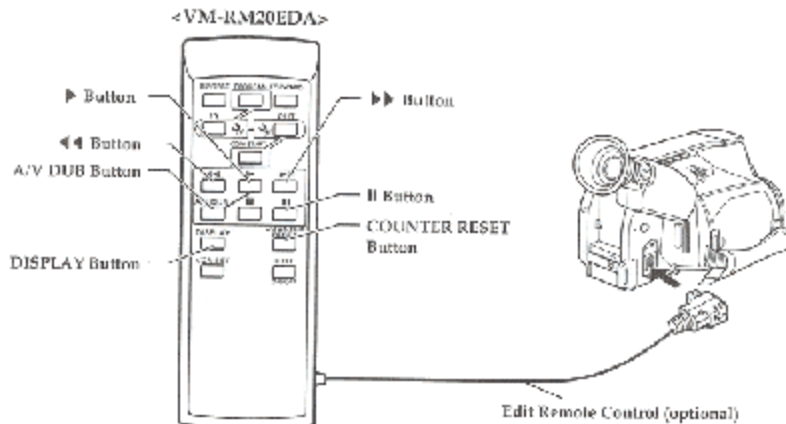

- 1 Hold down the red button on the CAM/ OFF/VIDEO switch while sliding the switch to VIDEO.
- 2 Insert a previously recorded tape in the camcorder.
- 3 Use the wireless remote control and press the ▶ PLAY button. Use the ▶ PLAY, ▶▶ F.FWD, and ◀◀ REW buttons to find the place where you want to stop dubbing. Press the START/STOP (PAUSE) button.
- 4 Display the linear time counter with memory ("Using Memory," p46). Press the COUNTER RESET button to set the linear time counter to "0:00:00M".
- 5 Use the ◀◀ REW and ▶ PLAY buttons to find where you wish to start dubbing. Press the START/ STOP || (PAUSE) button.
- 6 Place the CAM/OFF/VIDEO switch to CAM position. The record pause indicator "●||" appears and the camcorder is ready to record.
- 7 Press and hold the A/ V DUB button, then press ▶ (PLAY) button. This places the camcorder AN DUB pause mode. "●||" disappears replaced by "A/V DUB ||".
- 8 Press the || button. The audio/video dubbing starts. When the linear ear time counter reaches "0:00:00M" the cam corder stops automatically, recording only the portion of the tape that you selected.

**Note:** If the camcorder is in AV DUB pause or STILL mode for more than 5 minutes, the camcorder stops automatically to protect the tape.

**Note:** When the audio/video dubbed portion is played back, noise may appear at the end of the dubbed portion.

## General Maintenance

### Cleaning the Camcorder Heads

Dirt can accumulate on the video heads on the camera causing the playback picture to become blurred or appear as if video information is lost. This often means that the video heads are dirty. Use a video head cleaner such as a dry type head cleaning tape to clean the heads.

If after cleaning the heads the picture does not clear up consult your nearest dealer or VCR service center for professional head cleaning.



---

## Cleaning the Lens and Picture Tube of the Electronic Viewfinder

*The lens of the electronic viewfinder can be user-cleaned if dust, dirt, or other foreign matter adheres to it.*

1 Pull out the eye cup to the position where a mark can be seen (up to a half where it is pulled out all the way). The side with the mark should be up.

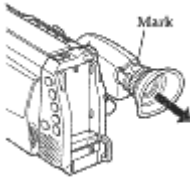

2 Turn the eye cup counterclockwise until it stops, then pull it out to remove.

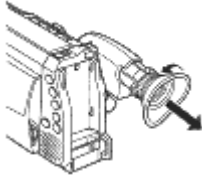

3 Clean the picture tube face and lens. To prevent scratching, use a soft nonabrasive cloth, swab or lens cleaning paper.

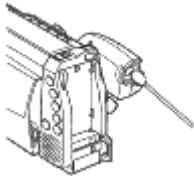

4 Face the rib up as shown above and push the eye cup in until it stops.

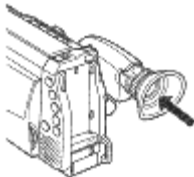

5 Turn the eye cup clockwise until it stops, then push it in all the way.



---

## Periodic Maintenance

A precision electromechanical device, the Hitachi VM-E455LA/VM-H755LA/VM-H655LA requires maintenance after a period of normal use. We expect that no other maintenance other than head cleaning will be required during the period of warranty unless the camcorder is used either heavily or seldom. Defective parts are covered by the warranty. Normal maintenance is the responsibility of the owner. Consult your dealer or local VCR service center for recommendations regarding normal maintenance based on your use patterns, location, and the age of the camcorder.

## Troubleshooting

*Quality is very important at Hitachi. We inspect and check every camcorder carefully at the factory under the most rigid quality control and inspection systems. If problems develop please check the following possible solutions before inquiring about professional service.*

### INSERTING OR REMOVING THE CASSETTE

Symptom	Check Point & Correction
Cassette holder cannot be opened when you slide the EJECT switch.	<ul style="list-style-type: none"> <li>• Connect the power source.</li> </ul>
Cassette cannot be inserted into cassette compartment.	<ul style="list-style-type: none"> <li>• Load cassette in direction indicated by arrow on cassette.</li> <li>• Cassette window must be toward outside.</li> </ul>

### CAMERA RECORDING

Symptom	Check Point & Correction
Picture does not appear in the viewfinder or on the LCD monitor.	<ul style="list-style-type: none"> <li>• Slide the CAM/OFF/VIDEO switch to CAM.</li> </ul>
The camcorder cannot go into the recording mode, even when the start/stop button is pressed.	<ul style="list-style-type: none"> <li>• Check the record-protect tab on the cassette. See page 18 for details.</li> <li>• Slide the CAM/OFF/VIDEO switch to CAM.</li> </ul>
Picture is out of focus. Auto-focus does not operate.	<ul style="list-style-type: none"> <li>• Make sure that "FOCUS" does not appear in the viewfinder or on the LCD monitor. If it is displayed, press FOCUS/VOL. control buttons to erase it.</li> <li>• Auto-Focus does not operate if a special-effects filter is attached or the objects shown on page 27 are being recorded.</li> </ul>
The created title does not appear.	<ul style="list-style-type: none"> <li>• Insert the clock battery, then create a title.</li> <li>• Do not remove the clock battery after creating a title.</li> <li>• When the stored title (prememo) is displayed in the viewfinder or on the LCD monitor, press the PLAY button.</li> </ul>



### NO OPERATION IS ACCEPTED

Symptom	Check Point & Correction
Power is turned on, but no button operations are accepted.	<ul style="list-style-type: none"> <li>• Remove the power source and the clock battery. And after about one minute, the display in the viewfinder or on the LCD monitor will be reset. Then set the information again.</li> </ul>

### PLAYBACK OF PRE-RECORDED CASSETTE

Symptom	Check Point & Correction
The PLAY button cannot be engaged.	<ul style="list-style-type: none"> <li>• Set the CAM/OFF/VIDEO switch to VIDEO.</li> </ul>
No picture appears on television screen when The PLAY is pressed. (TV is connected to the camcorder by using RF converter unit.)	<ul style="list-style-type: none"> <li>• Set the television to the camcorder channel (3 or 4) depending upon the selected channel in the RF channel select switch of RF converter unit.</li> </ul>
Interference on playback picture. (TV is connected to the camcorder by using RF converter unit.)	<ul style="list-style-type: none"> <li>• When you see the playback picture on your TV, adjust fine tuning knob on television set to obtain best picture.</li> </ul>
Picture bends at the top of the TV screen.	<ul style="list-style-type: none"> <li>• TV receiver is older type. It needs to be modified to work properly with camcorder.</li> <li>• Tape is damaged. Try another cassette.</li> </ul>
Color of your TV screen is too bright, too faint or change.	<ul style="list-style-type: none"> <li>• TV set has VIR circuit. Turn it off during playback.</li> </ul>
Date search function does not operate.	<ul style="list-style-type: none"> <li>• Slide the CAM/OFF VIDEO switch to VIDEO.</li> <li>• Insert the clock battery, set the date and time, then start recording.</li> <li>• Do not remove the clock battery after recording.</li> <li>• Do not eject the recorded cassette. Leave it in the camcorder.</li> </ul>

### BATTERY CONDITION

Symptom	Check Point & Correction
The (  ) indication in the electronic viewfinder or on the LCD monitor flashes to indicate battery is discharged.	<ul style="list-style-type: none"> <li>• Try another battery or charge the battery.</li> </ul>
The battery level indicator (  ) appears differently on the LCD monitor and in the viewfinder.	<ul style="list-style-type: none"> <li>• This does not indicate a fault; it is because the power consumed by the LCD monitor and the viewfinder is different.</li> </ul>

### NO OPERATION IS ACCEPTED

Symptom	Check Point & Correction
Power is turned on, but no button operations are accepted.	<ul style="list-style-type: none"> <li>• Remove the power source and the clock battery. And after about one minute, the display in the viewfinder or on the LCD monitor will be reset. Then set the information again.</li> </ul>

### TAPE DISPLAY

Symptom	Check Point & Correction
"TAPE" appears in the viewfinder or on the	<ul style="list-style-type: none"> <li>• Have you moved the camcorder or cassette from a cold place to a warm place so that its temperature changed abruptly? If the temperature has changed, remove the</li> </ul>

LCD monitor.	cassette and set the CAM/OFF/VIDEO switch to OFF, then wait for about one hour. <ul style="list-style-type: none"> <li>Remove the cassette and then try to reinsert: remove it several times. If the indication is still shown in the viewfinder or on the LCD monitor, use a cleaning tape to clean the heads and replace the cassette.</li> </ul>
--------------	--

## CAMCORDER MALFUNCTIONS

Symptom	Check Point & Correction
Random letters appear in the viewfinder or on the LCD monitor, or normal operation is interrupted.	<ul style="list-style-type: none"> <li>External interference may have caused the camcorder's microprocessor to malfunction temporarily. If random letters appear in the viewfinder or on the LCD monitor, or if normal operation is interrupted, remove the power source and clock battery, and then reattach them: the camcorder functions will return to their default settings.</li> </ul>

General Maintenance (cont.) pg. 58

## Specifications

### General Specifications

Power requirements	7.2V DC
Power consumption	3.4W (when recording/ LCD monitor OFF) 4.3W (when recording/LCD monitor ON)
Dimensions	4-11/16" W x 4-1/16" H x 7-1/8" D (118.5 mm x 102.5 mm x 181 mm)
Weight	VM-E455LA: 1.87 lbs (approx. 850g) without battery pack and cassette VM-H655LA 1.94 lbs (approx. 880g) without battery pack and cassette
Operating temperature	32°F - 104°F (0°C - 40°C)
Storage temperature	-4°F - 140°F (-20°C - 60°C)

### Video Recorder Specifications

Format	8 mm
Record/playback	Two video record/ playback heads
Video signal	EIA standard NTSC color
Tape speed	14.3 mm/sec
Video output	1.0 Vp-p, 75 ohm
Audio output	-7.8 dBs (316mVrms)
Fast forward/ rewind time	Less than 8 minutes with P6-120 cassette

### Camera Specifications

Scanning	525 lines / 60 fields / 30 frames
Required minimum illumination	0.3 lux
Pickup device	1/4" C.C.D.

## General Maintenance

Lens	F1.6 - 3.8 (4 - 88 mm) 22:1 power zoom lens with auto focus and auto iris functions
Lens diameter	46 mm

For U.S.A. only

### HITACHI

#### Service Hotline

To locate an authorized  
HITACHI service facility  
in the continental U.S.A.

#### **DIAL TOLL FREE**

7 days a week, 24 hours a day  
800 HITACHI  
1-800-448-2244

#### **Hitachi Home Electronics (America), Inc.**

Hitachi has made every effort to assure you hours of trouble free operation from your unit. However, should you require service, a network of Hitachi Authorized Service Facilities has been established in all 50 states and Puerto Rico. Each facility will provide you with convenient and expedient assistance. Our service "Hotline" operator will direct you to the Hitachi Authorized Service Facility nearest you. Just present proof of purchase and/or delivery receipts to the Hitachi Authorized Service Facility and service will be rendered in accordance with the terms of the limited warranty as stated on your warranty card or operating guide.

**Should you have any questions regarding in-warranty service, operation or technical assistance, please contact:**

#### **Hitachi Home Electronics (America), Inc.**

1855 Dornoch Court  
San Diego, CA 92173  
Tel (1-800-448-2244)

## Accessories Add Excitement

*We know that once you discover how much your Hitachi VM-E455LA/VM-H7655LA can add to your life you will want to use these accessories for even more excitement. Converter lenses and car cords are just a few of the exciting accessories available to you from Hitachi. Hitachi takes you to wherever your imagination leads.*

## Available Accessories

**Click to see Available Accessories**

To place an order for any of these items call our toll free number.

**1-800-HITACHI**

**1-800-995-4500**

## To Order in the United States

### By Phone

**1-800-HITACHI**  
**1-800-995-4500**

In Canada - Please use Canadian order form in French version of this manual - Page 61.



## FOR AUTHORIZED HITACHI SERVICE FACILITY IN CANADA

Please consult the following telephone numbers:

**1-800-HITACHI**

**1-800-995-4500**